



HEARTLAND[®]
RECREATIONAL VEHICLES

LANDMARK OWNER'S MANUAL
FIFTH WHEELS, TRAVEL TRAILERS & TOY HAULERS





DEAR VALUED CUSTOMER

CONGRATULATIONS! and thank you for your business. This owner's manual outlines the HEARTLAND RECREATIONAL VEHICLES, LLC LIMITED TWO (2) YEAR WARRANTY

We encourage you to follow the Product Delivery Inspection procedures with your selling dealer. You should receive an extensive walk through and demonstration of your RV, and the warranty statement contained in this manual should be fully explained to you. The desired result is that you have been informed of the warranty provided, the operation, the maintenance required, and details of the responsibilities of the manufacturer, dealer, and retail partnership.

At HEARTLAND RECREATIONAL VEHICLES, LLC, we want you to be able to enjoy your new recreational vehicle. In the following pages, you will learn about your warranty, the features of your HEARTLAND RV, and the maintenance necessary to ensure years of enjoyable use. We encourage HEARTLAND owners to review and pay special attention to the following:

- Warranty Statement – please read the full warranty statement.
- Weight rating – please review the proper loading, hitching and towing instructions for your safety and that of others.
- Care and Maintenance – review sealant maintenance requirements.
- Slide Room Operation – review operation instructions, maintenance, adjustments.
- LP and Appliances – review function and safety equipment provided.
- Tire and Lug Nut – review inflation and lug nut torque specifications.
- Modifications/Deviations – review which changes or alterations can void the warranty.
- Condensation – review causes and advice on how to reduce and control.

Your unit has been inspected by the factory, and received a final inspection at the dealership. Please allow your dealership to assist you in remedying any warranty issues, and should you need to contact our Elkhart, Indiana service facility, please contact us at 1-574-262-8030 / 877-262-8032

We wish you many seasons of happy camping with your HEARTLAND RECREATIONAL VEHICLES, LLC product.

Best Regards,

The "HEARTLAND Team"

Heartland Recreational Vehicles, LLC
Customer Service
2831 Dexter Drive
Elkhart, IN 46514
Ph. 574-262-8030 / 877-262-8032

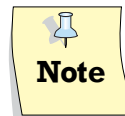

This manual is based on the latest information available at the time of publication. Due to continuous product development and improvements, Heartland Recreational Vehicles, LLC reserves the right to make changes in product specifications and components without prior notice or obligation. The most recent version of the owner's manual can be found on our web site "www.heartlandrvs.com" under the customer service heading.

PUBLISHED FEBRUARY, 2012
REVISED NOVEMBER, 2020

HEARTLAND RECREATIONAL VEHICLES, LLC LANDMARK BRAND LIMITED WARRANTIES FOR UNITED STATES AND CANADA

(EFFECTIVE FOR LANDMARK BRAND RECREATIONAL VEHICLES MANUFACTURED ON, OR AFTER, NOV. 1, 2017)

THESE LIMITED WARRANTIES COVER

1. Only the first retail purchaser, who purchases the recreational vehicle from an authorized Heartland Recreational Vehicles, LLC (“Heartland”) dealer, and who uses the recreational vehicle, under normal use, for its intended purpose of private single family travel; and
1. Except as otherwise excluded, Defects attributable to Heartland in the construction of the recreational vehicle. “Defect” means the failure of the recreational vehicle to substantially conform to Heartland’s design and manufacturing specifications and tolerances caused by a defect in materials used or workmanship performed by Heartland.

LANDMARK BRAND TWO (2) YEAR LIMITED WARRANTY

The Heartland Landmark Brand Two (2) Year Limited Warranty covers defects in material and/or workmanship supplied and attributable to Heartland in the construction of the recreational vehicle for a period of two (2) years. The warranty coverage starts, and begins to run, from the date of the original retail purchase.

*~ This Limited Warranty: (i) **only** covers Landmark brand recreational vehicles sold in, and remaining in, the United States and Canada; (ii) is **non-transferable** and is intended for the original retail owner only; (iii) is independent from and not part of the separate Three (3) Year Limited Structural Warranty set forth below; and, (iv) does not cover those items excluded under the section titled “What Is Not Covered.” ~*

LIMITATIONS, DISCLAIMERS AND EXCLUSIONS

1. This warranty is expressly in lieu of all other warranties, express or implied. TO THE EXTENT PERMITTED BY APPLICABLE LAW, ALL IMPLIED WARRANTIES, INCLUDING THE IMPLIED WARRANTIES OF MERCHANTABILITY, FITNESS FOR A PARTICULAR PURPOSE, QUALITY, DURABILITY, AND AGAINST LATENT DEFECTS, ARE HERBY DISCLAIMED. To the extent the implied warranties cannot be disclaimed under applicable federal or state law, all such implied warranties are limited in duration to the term of this Limited Warranty and are limited in scope of coverage to those portions of the recreational vehicle covered by this warranty. There is no warranty of any nature made by Heartland beyond that contained in this Two (2) Year Limited Warranty and the Three (3) Year Limited Structural Warranty. No person has authority to enlarge, amend or modify this Limited Warranty. The dealer is NOT Heartland’s agent. Heartland is not responsible for any undertaking, representation or warranty made by any dealer or others beyond those expressly set forth within this Limited Warranty.

~ Some states do not allow limitations on how long an implied warranty lasts, so the above limitation may not apply to you. ~

2. The first retail purchaser, and any person who is an intended or unintended user or beneficiary of the recreational vehicle, shall not be entitled to recover from Heartland any consequential or incidental damages resulting from any defect in the recreational vehicle, including fuel and transportation expenses to deliver the product to the servicing dealer, hotel rooms, travel expenses, meal expenses, towing charges, inconvenience, rental charges, loss of use, lost wages, and moisture damage such as mold and mildew, as well as rust and corrosion. The exclusion of consequential and incidental damages shall be deemed independent of, and shall survive, any failure of the essential purpose of this Limited Warranty.

~ Some states do not allow the exclusion or limitation of incidental or consequential damages, so the above limitation or exclusion may not apply to you. ~

3. Any action to enforce this Limited Warranty or any implied warranties or for revocation of acceptance shall not be brought more than ninety (90) days after expiration of the applicable warranty period defined above, or within One (1) year of the date of breach, whichever is sooner. The performance of repairs shall not suspend this limitations period from expiring.

~ Unless prohibited by state or provincial law, repairs will not extend the time when you must commence a breach of warranty claim and shall not extend the warranty coverage period. Some states and provinces do not allow the reduction of the time when a breach of warranty claim must be commenced, so the reduction in time when a breach of warranty claim must be commenced may not apply to you. ~

THREE (3) YEAR LIMITED STRUCTURAL WARRANTY

The Heartland Three (3) Year Limited Structural Warranty covers substantial defects in material and/or workmanship supplied and attributable to Heartland in the construction and assembly of the “structural” (as defined below) portions of the recreational vehicle, arising under normal use and service to the structural components. The warranty coverage starts, and begins to run, from the date of the original retail purchase and covers only those defects in structural components that are discovered and reported during the three (3) years from date of purchase.

- a. “Structural” portions of the recreational vehicle consist of: (a) exterior sidewalls, laminated or non-laminated, including fiberglass and wall studs; (b) floors, laminated or non-laminated, including decking and floor joists; (c) roofs, laminated or non-laminated, including decking and roof rafters; and, (d) slide out box exterior sidewalls; end walls; roofs; floors; skeletal framing; decking; and, roof material installation.
- b. This Warranty does not cover: front and rear fiberglass caps and any other cosmetic fiberglass attachments; aluminum siding (unless the root cause is the wall structure); exterior roof material (EPDM rubber, TPO, etc.); floor covering (carpet, linoleum, hardwood, tile, etc.); all sidewall, end wall, front and rear wall, roof and floor attachments; cosmetic issues; damage from water leaks not attributable to a defect; and, delamination caused by water intrusion from lack of required exterior seal maintenance as outlined in the Maintenance Schedule included in the Owner’s Manual.

*~ This Limited Structural Warranty: (i) **only** covers recreational vehicles sold in, and remaining in, the United States and Canada; (ii) is **non-transferable** and is intended for the original retail owner only; (iii) is independent from and not part of the separate Landmark Brand Two (2) Year Limited Warranty set forth above; and, (iv) does not cover those items excluded under the section title “What is Not Covered.” ~*

LIMITATIONS, DISCLAIMERS AND EXCLUSIONS

1. This warranty is expressly in lieu of all other warranties, express or implied. **TO THE EXTENT PERMITTED BY APPLICABLE LAW, ALL IMPLIED WARRANTIES, INCLUDING THE IMPLIED WARRANTIES OF MERCHANTABILITY, FITNESS FOR A PARTICULAR PURPOSE, QUALITY, DURABILITY, AND AGAINST LATENT DEFECTS, ARE HERBY DISCLAIMED.** To the extent the implied warranties cannot be disclaimed under applicable federal or state law, all such implied warranties are limited in duration to the term of this Limited Structural Warranty and are limited in scope of coverage to those portions of the recreational vehicle covered by this warranty. There is no warranty of any nature made by Heartland beyond that contained in this Three (3) Year Limited Structural Warranty and the Landmark Brand Two (2) Year Limited Warranty. No person has authority to enlarge, amend or modify this Limited Structural Warranty. The dealer is NOT Heartland’s agent. Heartland is not responsible for any undertaking, representation or warranty made by any dealer or others beyond those expressly set forth within this Limited Structural Warranty.

~ Some states do not allow limitations on how long an implied warranty lasts, so the above limitation may not apply to you. ~

2. The first retail purchaser, and any person who is an intended or unintended user or beneficiary of the recreational vehicle, shall not be entitle to recover from Heartland any consequential or incidental damages resulting from any defect in the recreational vehicle, including fuel and transportation expenses

to deliver the product to the servicing dealer, hotel rooms, travel expenses, meal expenses, towing charges, inconvenience, rental charges, lost wages, and moisture damage such as mold and mildew, as well as rust and corrosion. The exclusion of consequential and incidental damages shall be deemed independent of, and shall survive, any failure of the essential purpose of this Limited Structural Warranty. ~ *Some states do not allow the exclusion or limitation of incidental or consequential damages, so the above limitation or exclusion may not apply to you.* ~

3. Any action to enforce this Limited Structural Warranty or any implied warranties or for revocation of acceptance shall not be brought more than ninety (90) days after expiration of the applicable warranty period defined above, or within One (1) year of the date of breach, whichever is sooner. The performance of repairs shall not suspend this limitations period from expiring.

~ *Unless prohibited by state or provincial law, repairs will not extend the time when you must commence a breach of warranty claim and shall not extend the warranty coverage period. Some states and provinces do not allow the reduction of the time when a breach of warranty claim must be commenced, so the reduction in time when a breach of warranty claim must be commenced may not apply to you.* ~

REPAIR REMEDY AND BACK-UP REMEDY

1. If within the applicable warranty period a covered defect is found to exist, Heartland's sole and exclusive obligation is to repair any such defect.
2. If the primary repair remedy fails to successfully cure any defect after a reasonable number of repair attempts, Heartland may, as a back-up remedy, at its sole option, elect to either:
 - a. Pay owner diminution in value damages; or
 - b. Provide a similar replacement recreational vehicle, less a reasonable allowance for the owner's use of the original recreational vehicle.

The repair remedy and the back-up remedy **must** both be exhausted **and** these remedies must fail to fulfill their essential purpose before you can seek other legal or equitable remedies for breach of this express warranty or for breach of any implied warranty.

3. Heartland reserves the right to make parts and design changes from time to time without notice. Heartland reserves the right to make changes in the design of its products, or materials and/or components used in its products without incurring any obligation to incorporate such changes in any product previously manufactured.
4. Heartland makes no warranty as to the future performance of this RV, and neither the Landmark Brand Two (2) Year Limited Warranty, nor the Three (3) Year Limited Structural Warranty are intended to extend to the future performance of this recreational vehicle, or any of its materials, components or parts. The Landmark Brand Two (2) Year Limited Warranty and the Three (3) Year Limited Structural Warranty do not make any representations on how your recreational vehicle will perform in the future, but instead represents only what the remedy will be if a defect exists.
5. Any performance of repairs after the warranty coverage ends **or** any performance of repairs to those portions of your recreational vehicle excluded from coverage shall be considered "goodwill" repairs. Warranty repairs should be expected. Heartland may use new and/or remanufactured parts and/or components of substantially equal quality to complete a repair.
6. Warranty work, repairs or service to the recreational vehicle conducted by any party not specifically authorized by Heartland is not covered by the Limited Warranties and will void the Limited Warranties.
7. Warranty repairs, addressing defects with and/or damage to the recreational vehicle may have been performed at the factory during assembly **or** at the selling dealership after delivery of the recreational vehicle to your selling dealer. Normally, any defect and/or damage is detected and corrected at the factory **or** by the selling dealer during the inspection process. If you discover any defects or damage to the recreational vehicle when you take delivery, you **must** notify your dealer **or** Heartland within ten (10) days of the date of purchase to have the damage repaired at no cost to you.

ADDITIONAL INFORMATION CONCERNING HEARTLAND'S LIMITED WARRANTIES

DEALER'S OBLIGATIONS

The independent Heartland dealer, by agreement with Heartland, will maintain the recreational vehicle until it is sold to the first retail customer; will perform a comprehensive pre-delivery check procedure and inspection; will repair or replace any identified defective parts; will correct identified defects in workmanship; will present the retail owner with a copy of this warranty prior to the retail owner's entering into any written contract to purchase a recreational vehicle; and will mail to Heartland a warranty registration notice and the signed Limited Warranty.

CUSTOMER'S OBLIGATIONS

1. The owner is responsible for proper care, maintenance and cleaning of the recreational vehicle, including its exterior and interior products and components as more particularly described in the owner's manual and in the materials provided by the component manufacturers. Failure of any product or component caused by improper care, cleaning procedures, negligence or faulty maintenance is expressly excluded from the Limited Warranties.
2. Notwithstanding the foregoing, minor adjustments to components, including, but not limited to, adjustments to the interior or exterior doors, LP regulator pressure, cabinet latches and TV antenna control, will be performed by the dealer free of charge to the retail customer for a period of ninety (90) days from the original retail purchaser taking possession of the recreational vehicle.
3. It is the owner's responsibility to use the recreational vehicle for its intended purpose as described above and to observe and comply with all proper operating practices, instructions and safety regulations listed on the safety labels or in the owner's manual, and/or operating practices, and safety regulations required by law. Failure to comply with all rules, regulations and instructions will invalidate the Limited Warranties.
4. **Warranty Registration:** Your warranty registration records should be completed and delivered to the manufacturers of component parts. The selling dealership will assist you in completing and submitting the Heartland product warranty registration form. That form must be returned to Heartland within ten (10) days of your taking delivery of the RV. Your warranty will not be registered unless this warranty registration is completed and received by Heartland. Failure to file this warranty registration with Heartland will not affect your rights under the Limited Warranties as long as you can present proof of purchase, but it can cause delays in obtaining benefits under the Limited Warranties, and it may inhibit any servicing facility's ability to provide proper repairs and/or part replacement.

HOW TO OBTAIN WARRANTY SERVICE

If a problem occurs which the owner thinks is covered by either the One (1) Year Limited Warranty, or the Three (3) Year Limited Structural Warranty, the owner is responsible for contacting Heartland, or an independent, authorized Heartland dealer for warranty service. If you need assistance in locating an authorized warranty service facility, contact Heartland's warranty department by calling Heartland's Toll Free Customer Service number (877) 262-8032. For warranty service simply contact an independent, authorized dealer for an appointment, then deliver your recreational vehicle (at your expense) to the authorized warranty service facility. To assist in obtaining warranty service, please have the following information readily available when you contact Heartland, or an authorized dealer: (i) complete VIN Number; (ii) mailing address (please no P.O. Box numbers); and, (iii) daytime phone number. Heartland is located at 2912 Dexter Drive, Elkhart, IN 46514 and its mailing address is 2831 Dexter Drive, Elkhart, IN 46514.

WHAT IS NOT COVERED BY HEARTLAND'S LIMITED WARRANTIES

- Any recreational vehicle used for rental, business, commercial, disaster relief purposes, any purposes other than of private single family travel, or any recreational vehicle titled or registered in the name of a business entity;
- Any recreational vehicle that is not originally purchased through an authorized Heartland dealer, or any purchased through auction, repossession, salvage, or an otherwise damaged or distressed condition;
- Any recreational vehicle sold or registered or used outside the United States or Canada;
- Routine maintenance including, without limitation: caulking; waxing of the body of the recreational vehicle; tightening screws; lubricants; minor adjustments to doors, drawers, slide outs, awnings, window treatments, latches, locks, brakes beyond 90 days after retail sale; changing fuses, light bulbs; and, maintaining the air conditioning and heating systems;
- Accessories and equipment added or changed after the recreational vehicle leaves the factory;
- Accessories and equipment that are working as designed, but which owner is unhappy with the design;

- Design defects; redesign/re-construction of any part of the recreational vehicle; or anything related to wheel or axle alignment;
- Damage or loss that may result from not following proper operating practices, instructions, warning, or regulations, including but not limited to those contained in the owners manuals, on labels, or otherwise provided by law;
- Damage or loss caused in whole or in part by the misuse, abuse, neglect, off-road use, collision, fire, explosions, theft, vandalism, accident, improper customer or dealer installation, improper stowing of equipment, overloading or improper balancing of the load, low or high voltage, or unauthorized repair;
- Damage or loss caused in whole or in part by the unauthorized attachments, modifications or alterations to the structure, body, pin box, or frame of the recreational vehicle, including, but not limited to, installing trailer hitches for towing, or platforms for supporting cargo;
- Damage or loss caused by environmental conditions, including, but not limited to, rust, corrosion, sealant deterioration, chemical off-gassing, airborne pollutants, salt, tree sap, leaves and branches, animals, and hail damage; or flaking, peeling and chips or other defects or damages in or to the exterior or finish caused by rocks or other road hazards; or any injury, or loss or damage due to mold or fungi;
- Normal wear and usage, such as fading or discoloration of fabrics or exterior surface, carpet wear, cosmetic issues with the roof material(s) or its installation, or damage caused by condensation; defacing, scratching, dents and chips on any surface or fabric;
- Problems which may result from the tow vehicle selected by the owner, owner's operation or use of the tow vehicle, willful or negligent acts of the driver of the vehicle pulling the recreational vehicle, an accident involving the recreational vehicle, or the condition of any road surface, improper selection or installation of towing hitch on tow vehicle, weight distribution, sway control or equalizer equipment, or damage to the owner's tow vehicle; and,
- Equipment, products, components, appliances, or accessories covered by their own manufacturer's warranty including, by way of example, the microwave, refrigerator, ice maker, stove, oven, generator, frame, batteries, tires, roof air conditioners, water heater, furnace, washer, dryer, inverter, DVD players, televisions, stereo, radio, compact disc player, leveling jacks, vacuum cleaners, power converters, and other items not specifically manufactured by Heartland.

COMPONENT AND APPLIANCE WARRANTIES AND ADMINISTRATION

Some component part and appliance manufacturers issue limited warranties covering their products that are separate from Heartland's limited warranties. If a component or appliance manufacturer provides a warranty on its products, these warranties are separate and distinct from Heartland's Limited Warranties. However, to assist the retail customer, during Heartland's Landmark Brand Two (2) Year Limited Warranty coverage period, Heartland will administer those warranties; except for separate warranties covering tires, batteries, and generators, as Heartland does not administer those components' separate warranties. Therefore, during the two (2) year Limited Warranty coverage period, all warranty service claims on applicable components and appliances should be directed to Heartland through an authorized Heartland dealer or service center. After the Heartland Landmark Brand two (2) year Limited Warranty coverage period expires, all component and appliance warranty claims should be directed to the respective component or appliance manufacturers. Heartland is not warranting any component or appliance, only administering separately offered warranties from the component or appliance manufacture. In no way shall Heartland's limited warranties be modified or amended by this provision. To learn more on what specific components and appliances are not covered by this Limited Warranty, please contact Heartland Customer Service directly, or review the owner's packet inside your recreational vehicle.

LEGAL REMEDIES

1. At the option of Heartland, any and all claims, demands, causes of action or disputes arising out of or relating in any way to the Limited Warranties or the recreational vehicle shall be resolved exclusively in arbitration in accordance with the Indiana Arbitration Act (IC 34-57-1-1, et seq.), the Uniform Arbitration Act (IC 34-57-2-2, et seq.), and the Indiana Rules for Alternative Dispute Resolution, Rules 3.1 through 3.5. There shall be one (1) arbitrator appointed by the Elkhart Circuit or Superior Court, Elkhart County, Indiana, who shall be an attorney with professional experience in the recreational vehicle industry. All costs and expenses of the arbitration will be paid by the party against whom the arbitrator rules; however, each party will bear its own attorneys' fees.
2. In the event that Heartland does not elect to submit any dispute to arbitration or the foregoing arbitration provision is found to be unenforceable, exclusive jurisdiction for deciding legal disputes relating in any way to the Limited Warranties or the recreational vehicle must be filed in the courts within the state of manufacture.

3. The Limited Warranties shall be interpreted and construed in accordance with the laws of the state of Indiana. Any and all claims, controversies and causes of action arising out of or relating to the Limited Warranties, whether sounding in contract, tort, or statute, shall be governed by the laws of the state of Indiana, including its statutes of limitations, without giving effect to any conflict of law rule that would result in the application of the laws of a different jurisdiction.
4. By executing the acknowledgement section contained below, the retail purchaser agrees to the jurisdiction of the courts set forth above.

~ THIS WARRANTY GIVES YOU SPECIFIC LEGAL RIGHTS. YOU MAY ALSO HAVE OTHER RIGHTS, WHICH VARY FROM STATE TO STATE AND PROVINCE TO PROVINCE. ~

Purchaser Acknowledgement

I/We hereby acknowledge that I/we have read and understand the applicable Limited Warranties and Additional Information and accept the terms and conditions set forth therein, including the following sections: Limitations, Disclaimers and Exclusions; Repair Remedy and Back Up Remedy; Owner Obligations; What Is Not Covered; and, Legal Remedies.

DATE: _____

MODEL: _____

VIN #: _____

SIGNATURE: _____

SIGNATURE: _____

PRINTED: _____

PRINTED: _____

TABLE OF CONTENTS

DEAR VALUED CUSTOMER	1	POWER SYSTEMS	44
LIMITED WARRANTY	3	ELECTRICAL SYSTEM	46
REPORTING SAFETY DEFECTS	7	GENERATORS	48
OWNER'S INFORMATION	8	FIRE SAFETY	49
IMPORTANT SAFETY PRECAUTIONS	9	LP GAS SYSTEM	50
KEY INFORMATION	10	PLUMBING	55
CUSTOMER UPDATE FORM	13	APPLIANCES	59
PRE-TRIP CHECKLIST	15	EQUIPMENT	62
DRIVING SAFETY	16	SLIDE OUTS	64
MAINTENANCE SCHEDULE	18	EXTERIOR MAINTENANCE	66
MAINTENANCE RECORD	21	INTERIOR CARE	68
HITCHING & LOADING	23	WINTER STORAGE	69
WHEEL NUT TORQUE	29	PROLONGED OCCUPANCY	70
TIRES & BRAKING	31	MOLDS	72
GLOSSARY OF TIRE TERMINOLOGY	40	CHEMICAL SENSITIVITY	73
LEVELING	42		

REPORTING SAFETY DEFECTS

If you believe that your vehicle has a defect which could cause a crash or could cause injury or death, you should immediately inform the National Highway Traffic Safety Administration (NHTSA) in addition to notifying HEARTLAND RECREATIONAL VEHICLES.

If NHTSA receives similar complaints, it may open an investigation, and if it finds that a safety defect exists in a group of vehicles, it may order a recall and remedy campaign. However, NHTSA cannot become involved in individual problems between you, your dealer, or HEARTLAND RECREATIONAL VEHICLES.

To contact NHTSA, you may either call the Vehicle Safety Hotline toll-free at 1-888-327-4236 (TTY: 1-800-424-9153); go to <http://www.safercar.gov>; or write to: Administrator, NHTSA, 1200 New Jersey Avenue, S.E., Washington, DC 20590. You can also obtain other information about motor vehicle safety from <http://www.safercar.gov>.



WARNING: Cancer and Reproductive Harm -
www.P65Warnings.ca.gov

IMPORTANT OWNER'S SAFETY INFORMATION

This guide has been provided by HEARTLAND RECREATIONAL VEHICLES, LLC for the purpose of providing instructions about the operation and maintenance of this vehicle and its components. The only warranty offered by HEARTLAND RECREATIONAL VEHICLES, LLC is set forth in the written Two (2) Year Warranty that applies to this vehicle (see pp. 3-6). Nothing in this manual creates any other warranty, either expressed or implied.

Instructions are included in the manual for operating some of the components that are standard on this vehicle. Instructions may also be given for components that are options and may not appear on all vehicles. For more detailed information on the components installed, refer to the individual component manufacturer's operating instructions contained in the Owner's Information Package.

HEARTLAND RECREATIONAL VEHICLES, LLC has attempted to compile the most current information available at the time this guide was published. If the components in your unit vary significantly from what is described within this manual, then consult the instructions provided by the component manufacturer found in the Owner's Information Package.

Throughout this guide, reference is made to the following terms: Danger, Warning, Caution, and Note. These terms indicate important information that must be understood and followed. The definitions of these terms are:

DANGER indicates a hazardous situation which, if not avoided, will result in death or serious injury.

WARNING indicates a hazardous situation which, if not avoided, could result in death or serious injury.

CAUTION , used with the safety alert symbol, indicates a hazardous situation which, if not avoided, could result in minor or moderate injury.

NOTICE is used to address practices not related to personal injury. This applies to hazardous situations involving property damage only.

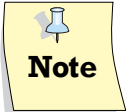
	Important information regarding the maintenance of your recreational vehicle.
---	---

Very Important:

Your warranty is activated **only** after HEARTLAND RECREATIONAL VEHICLES, LLC has received your signed warranty registration card from your selling dealer where it should have been signed. If you never signed this card or wish to make sure your warranty is activated, please contact your dealer or the HEARTLAND RECREATIONAL VEHICLES, LLC Warranty Department at 574-262-8030 or you may inquire in writing to HEARTLAND RECREATIONAL VEHICLES, LLC, 2831 Dexter Drive, Elkhart, IN 46514.

IMPORTANT SAFETY PRECAUTIONS

You'll find many safety recommendations throughout this section, and throughout this manual. The recommendations on these pages are the ones we consider to be the most important.

Do Not Allow Passengers to Ride in the Trailer During Travel

The transport of people puts their lives at risk and may be illegal. The trailer does not have seat belts, therefore, it is not designed to carry passengers.

Reducing Fishtailing or Sway

Sway or fishtailing is the sideways action of a trailer caused by external forces. Excessive sway of your travel trailer can lead to the rollover of the trailer and tow vehicle resulting in serious injury or death. Be sure to follow the instructions and warnings as outlined on page 27.

Mold

There are mold and mold spores throughout the indoor and outdoor environment. There is no practical way to eliminate all mold and mold spores in the indoor environment; the way to control indoor mold growth is to control moisture (see page 74).

Towing and Weight Distribution

Weight distribution is an important factor when loading your fifth wheel or travel trailer. A recreational vehicle with the cargo distributed properly will result in efficient, trouble-free towing (see page 27).

Formaldehyde

Formaldehyde is an important chemical used widely in building materials and numerous household products. It is also a by-product of combustion and certain other natural processes. Thus, it may be present inside the trailer with some individuals being sensitive to it. Ventilation of the unit normally reduces the exposure to a comfortable level (see page 75).

Generator Safety

Do not operate the generator in an enclosed building or in a partly enclosed area such as a garage. Nor should the generator be operated while sleeping. Be sure to follow all instructions and warnings in this manual and the manual provided by the generator manufacturer (see page 49).

Lug Nut Torquing

Being sure wheel mounting nuts (lug nuts) on trailer wheels are tight and properly torqued is an important responsibility that trailer owners and users need to be familiar with and practice. Inadequate and/or inappropriate wheel nut torque (tightness) is a major reason that lug nuts loosen in service. Loose lug nuts can rapidly lead to a wheel separation with potentially serious safety consequences (see page 30).

Appliances and Equipment

The appliances (stove, refrigerator, outdoor grills, etc.) and equipment (hot water heater, furnace generator, etc.) typically operate on LP gas. LP gas is flammable and is contained under high pressure. Improper use may result in a fire and/or explosion. Be sure to follow all instructions and warnings in this manual (see pages 60-64) as well as the specific owners' manuals of the appliances and equipment.

Tire Safety

Properly maintained tires improve the steering, stopping, traction, and load-carrying capability of your vehicle. Underinflated tires and overloaded vehicles are a major cause of tire failure. For more information on tire safety, please see pages 35.

KEY INFORMATION

Specification Label:

There are two main numbers used to identify the vehicle. The Vehicle Identification Number (VIN) is the legal identification of the completed vehicle. The VIN is the number used by the state for vehicle registration. The HEARTLAND Serial Number is a six digit number that is comprised of the last six digits of the VIN. This HEARTLAND Serial Number is needed whenever making an appointment for service or ordering parts through your HEARTLAND Dealer or Service Center. This number can be found on the placard at the entry door and on the Customer Care Card received from HEARTLAND. Below is a sample of the placard located in the kitchen. On this Trailer Weight Rating placard you will find:

1. The VIN Number
2. GVWR of the unit.
3. Cargo carrying capacity of the unit.

Important Facts:

If you are traveling or move, any authorized dealer, at their discretion, may provide service. Keep your warranty registration form with the vehicle at all times since it must be presented for warranty service. This form is your proof of purchase and provides the date of retail sale, both of which are necessary to determine warranty eligibility.

Important Facts:

Please inspect your recreational vehicle at the time of delivery and make sure you accept it as delivered to you. This recreational vehicle has been sold to an independent dealer, and not an agent of HEARTLAND RECREATIONAL VEHICLES, LLC for resale in the ordinary course of the dealer's business on terms and conditions and equipped as he and you determine and your agreement is solely with the dealer, not HEARTLAND RECREATIONAL VEHICLES, LLC. HEARTLAND RECREATIONAL VEHICLES, LLC does not participate in retail sales or retail contracts in any instance, other than by terms of this Limited Warranty.

Important Facts:

Using an RV in temperatures above 80 degrees or below 32 degrees Fahrenheit will require additional equipment to properly cool the RV or prevent freezing of the RV systems and components. Additional care or preventative measures should always be exercised when using an RV in extreme temperatures.

RECREATION VEHICLE TRAILER CARGO CARRYING CAPACITY

VIN: 5SFG3424BE216986 DRY WEIGHT: 4573.2 Kg or 10082 Lbs.

The weight of cargo should never exceed 1710.1 Kg or 3770 Lbs

CAUTION:

a full load of water equals 215 kg or 473 Lbs. of cargo @1 kg/L (8.3 lb/gal)

MANUFACTURED BY/FABRIQUE PAR: HEARTLAND RECREATIONAL VEHICLES DATE: 2/25/2010

GVWR/PNBV 6305.0 Kg 13900 (LB)

GAWR (EACH AXLE)/PNB (CHAQUE ESSIEU) 2721.6 Kg 6000 Lb TIRES/PNEU ST235/80/R16 E

RIM/JANTE 16 x 6

COLD INFL. PRESS./PRESS. DE GONFL. A F 552 KPA (80 PSI/LPC)

THIS VEHICLE CONFORMS TO ALL APPLICABLE U.S. FEDERAL MOTOR VEHICLE SAFETY STANDARDS IN EFFECT ON THE DATE OF MANUFACTURE SHOWN ABOVE. THIS VEHICLE CONFORMS TO ALL APPLICABLE STANDARDS PRESCRIBED UNDER THE CANADIAN MOTOR VEHICLE SAFETY REGULATIONS IN EFFECT ON DATE OF MANUFACTURE. - CE VEHICULE EST CONFORME A TOUTES LES NORMES QUI LUI SONT APPLICABLES EN VERTU DU REGLEMENT SUR LA SECURITE DES VEHICLES AUTOMOBILES DU CANADA EN VIGUEUR A LA DATE DE SA FABRICATION

V.I.N./N.I.V. 5SFG3424BE216986 TYPE/TYPE: TRAILER / TRA / REM MODEL: 32RL Greystone

TIRE AND LOADING INFORMATION
RENSEIGNEMENTS SUR LES PNEUS ET LE CHARGEMENT

The weight of cargo should never exceed

1710.1 Kg or 3770 Lbs.

CAUTION: a full load of water 215 kg 473 lbs of cargo @ 1kg/L (8.3 lb/gal)

TIRE PNEU	SIZE DIMENSIONS	COLD TIRE PRESSURE PRESSION DES PNEUS A FROID	SEE OWNER'S MANUAL FOR ADDITIONAL INFORMATION
FRONT AVANT	ST235/80/R16 E	80 PSI / 552 KPA	VOIR LE MANUEL DE L'USAGER POUR PLUS DE RENSEIGNEMENTS
REAR ARRÈRE	ST235/80/R16 E	80 PSI / 552 KPA	
SPARE DE SECOURS	ST235/80/R16 E	80 PSI / 552 KPA	

Important Facts:

HEARTLAND RECREATIONAL VEHICLES, LLC reserves the unrestricted right at any time and from time to time to make changes in the design of and/or improvements upon its product without thereby imposing any obligation upon itself to make corresponding changes or improvements in or upon its products already manufactured. HEARTLAND RECREATIONAL VEHICLES, LLC further reserves the right to substitute parts or components of substantially equal quality in any warranty service required by operation of this Limited Warranty.

Important Facts:

Like any other product, a recreational vehicle and the products installed in it will require care and maintenance attention by the owner and occupants. Please read and follow all care and maintenance manuals and instructions supplied with your recreational vehicle.

Key Information to have on hand (HEARTLAND customer should fill out):

All warranty work needs to be completed during the term of the warranty.

Warranty beginning date: ____/____/____

Warranty ending date: ____/____/____

VIN#: _____

Note: All service work performed after the expiration date will not be covered by HEARTLAND RECREATIONAL VEHICLES, LLC.

Original Owner: _____

Phone Number: _____

Dealership Purchased from: _____

Phone Number: _____

Second Owner: _____

Phone Number: _____

Person or Dealership Purchased from: _____

Phone Number: _____

OUR VALUED CUSTOMERS

If, for any reason, you have a problem obtaining satisfactory and timely warranty service that may substantially impair the use, value or safety of your HEARTLAND RECREATIONAL VEHICLES, LLC product, please call us so that we may attempt to resolve your concerns. Authorized dealers are independent contractors and independently owned businesses. This is also true of the authorized service centers.

Please note, your HEARTLAND RECREATIONAL VEHICLES, LLC warranty covers warrantable repairs that are performed by an authorized HEARTLAND RECREATIONAL VEHICLES, LLC dealer at their service center or facility only. It is important for the owner to know that if you are unable to bring your unit in for repairs, HEARTLAND RECREATIONAL VEHICLES, LLC is not responsible for any costs incurred for the service call charge, or time accrued to come out to your unit.

Can't find a dealer? Have an emergency? Heartland customer service can be reached at 574-262-8030/ 877-262-8032. We can help locate a dealer nearby or, in case of emergency or special circumstances, provide authorization to a local repair facility.

Before using any non-authorized dealer for any warranty repair – call Heartland first!



CUSTOMER INFORMATION UPDATE FORM

HEARTLAND RECREATIONAL VEHICLES, LLC strives to keep the most accurate and current customer information in its files in order to maintain good customer relations.

If you bought this unit new, we have your information from the warranty registration form which you have sent to us on file. If, however, you purchased this unit as used then we ask that you complete the following information and mail it or fax it to us at 574-262-8340 so that we can be sure that our records are updated.

Please note that the date of purchase on the card will show the original date the vehicle was first purchased and is the date applicable warranties originated. **Note: the warranty on a HEARTLAND RECREATIONAL VEHICLES, LLC coach is non-transferable.** This customer information update form is for record keeping purposes only. If you have any questions, please contact a HEARTLAND RECREATIONAL VEHICLES, LLC service representative.

DATE: _____ COACH VIN NO.: _____

CUSTOMER FULL NAME: _____

CUSTOMER ADDRESS: _____

TELEPHONE NUMBER: _____

EMAIL ADDRESS: _____

PURCHASED FROM: _____

ADDRESS: _____

HEARTLAND RECREATIONAL VEHICLES, LLC ATTN: Dealer Services/Warranty Department 2831 Dexter Drive Elkhart, IN 46514 Phone No. 574-262-8030
--

PRE-TRIP CHECKLIST

(AT HOME)

Have read and understood your owner's manual? _____
 If not, please do so now.

EXTERIOR:

- All objects secure _____
- Awnings locked _____
- Tires at proper pressure (including spare)..... _____
 (check for wear/damage)
- Wheel lug nuts tightened to proper torque _____
- Hitch and/or pin box secured properly _____
- All exterior lights operational _____
- Battery (batteries) fully charged, fluid level okay _____
- Brakes checked for operation _____
- Secure cargo and lock compartment doors..... _____
- Under-carriage items secure _____
- Slide rooms are sealed tightly when closed _____

INTERIOR:

- Antenna lowered _____
- Roof vents lowered _____
- Refrigerator locked..... _____
- Water heater OFF _____
- Water pump OFF _____
- Fresh water tank level..... _____
- Waste water tank level..... _____
- Toilet operational..... _____
- Furnace OFF..... _____
- LP Gas System checked..... _____
- Cooktop Cover CLOSED _____
- Drawers, Closets, Windows CLOSED..... _____
- Television Swivel Trays LOCKED _____

(AT CAMPSITE)

FOLLOW THE PREVIOUS CHECKLIST WITH THESE ADDED POINTS:

EXTERIOR:

- Disconnect all shore lines _____
 (City water, electric, sewer, cable)
- Hook up tow vehicle _____
- Remove wheel chocks _____
- Retract step _____
- Store camping equipment _____

CHECK CLEARANCES PRIOR TO PULLING OUT!

This checklist may seem like it contains basic items, but many are taken for granted and can spoil a trip if not attended to prior to moving the trailer.

You may want to use this list as a start for your own Pre-Trip checklist, which may include your personal camping gear and food preferences.

ITEMS TO CARRY:

- Local, state and national maps. Truck atlases can be useful for showing maps, refueling stations and truck repair facilities.
- An emergency road kit and flashlight.
- An assortment of spare fuses.
- An assortment of hand tools.
- 12 Volt DC test light may be helpful when speaking with a technician.
- A battery hydrometer to check the condition of battery electrolyte.
- Polarity tester to check 120 AC outlets.
- Potable/non-potable water hoses and a water pressure regulator.

DRIVING SAFETY

Towing a recreational vehicle may be a new experience for you. Find out what gears are right for your vehicle. For sharp turns, reduce your speed and swing wide after considering other traffic and obstacles in the intersection. Proper braking is extremely important for safety. The total weight being towed is much greater than a car, so it is important to anticipate traffic signals, stop signs and other traffic. Decelerate slowly, whenever possible, to prevent undue wear on brakes and tires. When passing a semi, bus or other large vehicle from either direction, air turbulence may cause the RV to sway slightly. Improper use of a recreational vehicle may cause physical damage and/or personal injury to the vehicle operator, occupants and others. Other precautions include:

- Never exceed posted speed limit; reduce speed when required by weather, traffic or road conditions.
- Use extreme caution when going downhill. Excessive speed may cause loss of control.
- Never attempt to pass on a curve or anywhere the view of the road ahead is restricted.
- Always check recreational vehicle brakes, lights and breakaway switch before starting out on a long trip. Confirm that brakes are applied evenly. Uneven braking will pull the trailer to one side, which may cause a loss of control when towing.

WARNING

DO NOT RIDE OR ALLOW OTHERS TO RIDE INSIDE THE RECREATIONAL VEHICLE WHILE IT IS BEING TOWED. SEAT BELTS ARE NOT PROVIDED AND TRANSPORTING OF INDIVIDUALS AND PETS COULD RESULT IN DEATH OR SERIOUS INJURIES OF THEM.

Tow Vehicle

It is important that the recreational vehicle is matched with an appropriate tow vehicle. A tow vehicle with an inadequate gross combined weight rating (GCWR) may experience mechanical failures and may not provide adequate towing stability. Consult your dealer for help in selecting the vehicle hitch and related hitching accessories.

Tips For Driving

Due to the overall vehicle length, the turning radius is much wider than a standard automobile. Always pay close attention to the perimeters: front, sides, rear, roof and undercarriage- Make sure the surrounding area is clear of any obstacles. Swerves and sharp turns, especially performed at high speeds, could result in the loss of control of the vehicle. Drive with extra caution to avoid situations which might require quick momentum changes. When passing another vehicle, allow extra time and space due to the additional length and weight. Practice using the brakes away from traffic to get the feel of the distance required to stop the vehicle.

When traveling, make sure bridges can support the combined weight of the tow vehicle and recreational vehicle. Tonnage limits for bridges should be posted at entrances. Also, check the posted height of overhead clearances. Keep in mind road surfaces may have been repaved or become packed with snow. Therefore, the actual posted clearance height may not apply.

If a problem occurs, do not panic. If a sudden bumping or fish-tailing occurs, it may indicate a flat tire. Do not jam on the brakes or suddenly accelerate in an attempt to drive out of it. Instead, come to a stop slowly while driving as straight as possible. If conditions permit, coast to a very slow speed and try to avoid braking, except when the wheels are straight ahead and the trailer and tow vehicle are in line with each other.

If the vehicle begins to fishtail when accelerated to highway speed, back off the accelerator. This should stop the fish-tailing. If it begins again when speed increases, stop and check the load, which may not be distributed evenly from side to side, or is too far back to put a sufficient load on the hitch pin. Redistribute the load, as necessary, before continuing.

Driving Cautions:

- Avoid getting too close to the edge of the road, a soft shoulder may not support the weight of the vehicle.
- Driving lanes in work zones can be uneven, congested and more narrow than usual.
- Be cautious of road debris which can damage the undercarriage of the vehicle or cause damage to the tires or wheel rims.
- Keep in consideration that posted speed signs are for passenger automobiles. Therefore, use extra awareness of the driving conditions and an appropriate speed for a vehicle with trailer, especially on corners and mountain roads.

- Downgrade speed should be at least 5 mph less than upgrade speed, or downgrade speed should be attainable within three seconds of a brake application.

NOTICE

TOWING ANYTHING BEHIND YOUR RV COULD CAUSE DAMAGE TO THE FRAME AND WILL VOID YOUR FRAMES WARRANTY.

Right Turns

Negotiating a right-hand turn while pulling a recreational vehicle can be difficult, but can be negotiated well using these tips:

- As the turn approaches, look into the mirror to ensure the lane to the left is clear, then move wide over to the left.
- Make the turn slowly.
- Check mirrors frequently. Be aware of necessary clearance and space management for the trailer while turning.

Night Driving

- Be well rested and alert when driving. If necessary, find a safe stopping place to rest until you are ready to continue.
- Avoid using any interior lights while driving. They can create a glare on the windshield decreasing visibility.
- Dim dash lights to a comfortable level to reduce glare.

Extreme Heat and Hot Weather Conditions

Check tire pressure frequently when traveling in hot conditions. Tire air pressure increases with heat. Do not let air out of a hot tire. When the tires cool down they return to the previous tire pressure.

Winter and Cold Climate Conditions

- Keep speeds slow and steady; make moves gradually and increase the visual distance for a gain in reaction time.
- If the road or weather conditions are treacherous, find a safe stopping place and wait for conditions to improve.
- Remove ice from the entry step to avoid slipping.

Wet Conditions:

- The risk of hydroplaning is increased if tires are worn or improperly inflated.
- Heavy rain or standing water can affect brake application.

Refueling:

- Be aware of the fuel port location on the tow vehicle. There may not be adequate space to turn around in the parking lot in order to reposition for the pump.
- Check overhead clearance before pulling through the fuel island.
- Be aware of the concrete/steel posts installed around the fuel island.
- Avoid running over the fuel hose as it can get caught and cause damage to the tow vehicle or recreational vehicle.

WARNING

AVOID THE RISK OF FIRE OR EXPLOSION. TURN OFF ALL PILOT LIGHTS AND APPLIANCES BEFORE REFUELING.

Emergencies:

If an emergency situation occurs, use the appropriate braking technique and pull off the roadway a safe distance from traffic if possible. Set the parking brake and turn on the hazard warning flashers, especially when parked alongside traffic lanes.

An emergency road kit should include at least three reflective warning signs, road flares, a flashlight, spare automotive fuses and an assortment of hand tools. The recreational vehicle is equipped with a fire extinguisher inside, near the entry door. Display road flares or reflective warning signs if the vehicle is along the road for any length of time. Guidelines for placing the warning triangles depend upon the road characteristics and visibility. The standard placement is 10', 100' and 200' from the rear of the recreational vehicle when on a divided highway or one-way road. On a two-way road with traffic traveling both directions the same placement would also be required at the front of the recreational vehicle. Roads with curves and hills may require placing warnings 500' behind the vehicle in order to safely warn approaching traffic.

MAINTENANCE SCHEDULE

*Tighten wheel bolts or nuts every 50 miles for the first 200 miles & after every change in wheel mounting. (Torque to 120-125 ft.-lbs.) Adjust brakes after first 200 miles then at above listed intervals	INSPECT/ TEST BEFORE EACH TRIP	MONTHLY	EVERY 3 MONTHS	EVERY 6 MONTHS	YEARLY	AS REQUIRED BY MANUFACTURER
Axle and springs	X			X		
Batteries	X			X		
Water level	X			X		
Brakes	X			X	X	
Exterior lighting	X				X	
Fresh water system	X				X	
Have all appliances serviced						X
Lp gas system	X					
Pigtail connection	X				X	
Roof sealant			X			
Roof vents				X		
Safety breakaway switch operation	X				X	
Sidewall sealants			X			
Tire lug nuts (after initial 50 mile check)	X					
Tires (condition and pressure)	X					X
Underbelly, check for tears or leaks				X		
Wheel bearings				X		X
Seals – doors, windows, vents, external seams			X			
Clean exhaust fan filter and blades			X			
Test smoke alarm and lp detector	X					
Check operation of windows, latches and hinges			X			
Clean the roof ducted air conditioner filter(s)			X			
Inspect and reseal shower area, where necessary			X			
Lubricate exterior door hinges and latches with a graphite (silicone) lubricant			X			
Check, clean and tighten battery cables			X			
Rotate tires, as recommended by the tire manufacturer						X
Check all appliances for proper operation	X			X		
Have the heat and ignition inspected by qualified technician				X		
Inspection of roof seams and joints (performed by an authorized service center suggested)					X	
Sanitize the fresh water system	X				X	
Wax and buff all gel-coat surfaces (as described in owner's guide – where applicable)					X	



MAINTENANCE RECORD

ROUTINE MAINTENANCE

All routine maintenance is the responsibility of the owner and is not covered by the HEARTLAND RECREATIONAL VEHICLES, LLC Limited Warranty. Use the maintenance record to record all performed maintenance as required. Please note that damage caused by improper or un-applied maintenance is not covered by the HEARTLAND RECREATIONAL VEHICLES, LLC Limited Warranty. Use and conditions may dictate more frequent maintenance than suggested.

Items supplied by other manufacturers may require specific individual maintenance not listed herein. Please refer to the manufacturers’ suggested maintenance guidelines in the Owner’s Information Packet.

IMPORTANT: All adjustments and alignments within the first three (3) months from date of original purchase are subject to warranty coverage. Thereafter, these items are considered routine maintenance.

Date	Miles	Description Of Service Work Performed	Service Performed By	Cost	

MAINTENANCE RECORD

Date	Miles	Description Of Service Work Performed	Service Performed By	Cost

HITCHING & LOADING

Hitches

You should become comfortable hooking up your vehicle with practice. There are several types of vehicle hitches available. Be certain to use the one recommended by your tow vehicle manufacturer and that meets the weight requirements of your vehicle. Those described here are typical, but have your dealer demonstrate and explain the proper hitching and unhitching procedure for your vehicle.

WARNING

AN IMPROPERLY COUPLED TRAILER OR 5TH WHEEL CAN RESULT IN DEATH OR SERIOUS INJURY.

USE OF A TOW VEHICLE WITH A TOWING CAPACITY LESS THAN THE LOAD RATING OF THE TRAILER CAN RESULT IN LOSS OF CONTROL, AND MAY LEAD TO DEATH OR SERIOUS INJURY.

Be sure your hitch and tow vehicle are rated for the Gross Vehicle Weight Rating (GVWR) of your vehicle. Be sure the hitch load rating is equal to or greater than the load rating of the coupler. Be sure the hitch size matches the coupler size. Observe the hitch for wear, corrosion and cracks before coupling. Replace worn, corroded or cracked hitch components before coupling the RV to the tow vehicle. Be sure the hitch components are tight before coupling the RV to the tow vehicle.



Hitching a Fifth Wheel Trailer

To hitch a 5th wheel, lower or remove the tailgate. Release the plate jaws by pulling the handle. It may be necessary to raise or lower the trailer with the front landing gear to align the pin with the jaw plates. Once connected, put your truck in drive and apply pressure to the hitch to ensure it is locked. Then retract your landing gear by using the switch or by turning the crank handle (if equipped) to raise the jacks off the ground as far as possible.

A lubrication point of major importance is the contact area where the pinbox plate rests on the hitch saddle. A liberal quantity of grease is often used on this surface, but that can be messy. After-market lubrication pads are also available, which can be attached to the pinbox plate to eliminate the need for grease. A typical type of lubrication pad is a thin sheet of graphite impregnated Teflon that is riveted to the pinbox plate. When using lubrication pads make it a matter of routine maintenance to inspect for pad wear. Before and after each trip, all nuts, bolts, safety pins and other hitch related hardware should be inspected.

NOTICE

USE OF A GOOSENECK ADAPTOR CAN CAUSE DAMAGE TO THE STRUCTURE OF YOUR FIFTH WHEEL AND WILL VOID YOUR LIMITED WARRANTY.

- Inspect the kingpin box mounting bolts at least every 2,000 miles. Using a torque wrench, tighten kingpin box bolts to 60-70 ft. lbs.
- Inspect the kingpin latch plate and saddle to make sure there is no evidence of excess wear or damage.
- Inspect the kingpin, pin-box plate and saddle to make sure there is no evidence of excess wear or damage.
- Lubricate the latch bolt and pivot point of the latch plate with SAE 30 oil at least every six months.
- Grease the load-bearing surfaces of the fifth wheel hitch with lithium based grease every 2,000 miles of operation to reduce wear and provide easier turning. As an alternative, use a grease-free lubrication pad between the hitch saddle and the pinbox plate.
- Inspect and clean the hitch latch plate before each use.
- Grease the pivot points between the rails and hitch with lithium-based grease every 2,000 miles of operation.
- Replace all worn or damaged parts.

Electrical Connection

Plug the pigtail on the vehicle into the electrical harness on the truck. Be sure there is enough slack to allow the vehicle to turn without disconnecting the pigtail. Make sure all lights and the brakes work prior to moving the vehicle. Current draw should not exceed ten amps for each designated light circuit. The tow harness wires are coded as follows:

1. White, 8 gauge – Ground
2. Blue, 12 gauge – Brake
3. Green, 14 gauge – Clearance Lights
4. Black, 14 gauge – Charge Line
5. Red, 14 gauge – Left Turn
6. Brown, 14 gauge – Right Turn
7. Yellow, 14 gauge – Aux

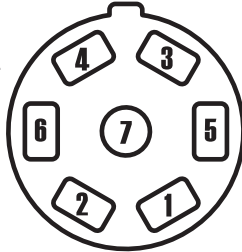

NOTICE

WHILE IT IS POSSIBLE TO OPERATE 12V ITEMS IN THE RV THROUGH A TOW VEHICLE CHARGE LINE, IT IS NOT RECOMMENDED DUE TO THE HIGH POWER CONSUMPTION OF SOME ITEMS.

Safety Breakaway Switch

Attach the safety breakaway tether to the truck body. DO NOT attach the cable to the plate handle, hitch plate base or plate mounting brackets. Adjust the cable so both vehicles may turn freely without pulling the pin from the switch. Lubricate the breakaway pin periodically to ensure good operation. **Make sure the pin is securely in place each time before using the trailer.** The tow

vehicle battery will supply power for the safety breakaway switch pin if a separation occurs. However, if the pigtail also disconnects, the vehicles brakes will not engage unless an RV battery is installed in the vehicle and is charged.

NOTICE

DO NOT USE THE BREAKAWAY SWITCH AS A PARKING BRAKE, AS IT IS INTENDED FOR EMERGENCY USE ONLY AND SUCH USE WILL DRAIN YOUR RV BATTERY.

SAFETY BREAK-AWAY SWITCH WILL NOT OPERATE

UNLESS CONNECTED TO A POWER SOURCE EQUIVALENT TO OR GREATER THAN AN AUTOMOTIVE TYPE 12 VOLT, 12 AMP HOUR WETCELL BATTERY.

Typical Wiring Diagram for Seven-Way Plug

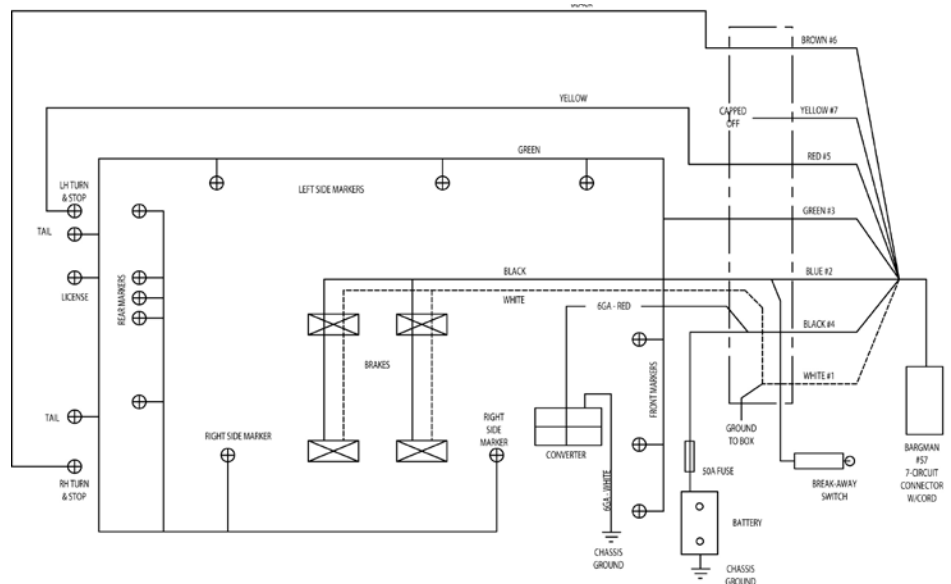

Ride Height of Vehicle – Clearance

When the vehicle is connected to the tow vehicle, check the ground clearance and front to rear pitch of the vehicle. If the front of the unit is too high, weight will be transferred behind the axles, causing the unit to fishtail and the rear axle tires to prematurely wear. If the front of the unit is too low, additional weight will be transferred to the truck. To achieve proper ride height, adjust the pin box by removing the bolts on each side and raising or lowering the box until the proper holes are aligned, then reinsert and tighten the bolts. **Retighten the pin box bolts every 50 miles for the first 500 miles and prior to every trip thereafter.**

WARNING

NEVER OVERLOAD YOUR 5TH WHEEL. DO NOT EXCEED THE RATED LOAD OF THE RV OR THE RATED LOAD OF ANY AXLE! OVERLOADING CAN CAUSE LOSS OF CONTROL OF THE UNIT, WHICH CAN RESULT IN SEVERE PERSONAL INJURY OR DEATH. OVERLOADING CAN ALSO CAUSE PROPERTY DAMAGE TO THE UNIT, ITS CONTENTS AND THE TOW VEHICLE.

Dangers of Overloading

During the design and development of our vehicles, the number and size of storage compartments and the liquid tank capacities are maximized for value and convenience. However, **be mindful that if all holding tanks are filled to capacity, and all storage compartments and cupboards are filled to the maximum volume, the vehicle could be overloaded causing an unsafe condition.** Refer to the manufacturer's labels posted inside and outside of the unit for weight information.

NOTICE

UNDER NO CIRCUMSTANCES SHOULD THE ENGINE OF YOUR TOW VEHICLE BE ALLOWED TO "LUG" OR PULL HARD FOR EXTENDED PERIODS OF TIME. SUCH MISUSE CAN CAUSE ENGINE FAILURE.

In addition to causing premature wear, **overloading can cause problems in the area of handling characteristics. An overloaded vehicle will take longer (time and distance) to stop in an emergency. Overloading can also cause added wear to components such as tires and wheel bearings. Overloading can also cause overheating of the tow vehicle in some instances.**

To avoid overloading, you must be aware of your vehicle weight situation at all times. Know where you stand when it comes to GVWR, GAWR and your current GVW AND UVW. The following is a key to understanding these terms:

Gross Vehicle Weight Rating (GVWR): is the maximum permissible weight of this trailer when fully loaded. It includes all weight at the trailer axle(s) and tongue or pin.

Unloaded Vehicle Weight (UVW): is the weight of this trailer as manufactured at the factory. It includes all weight at the trailer axle(s) and tongue or pin. If applicable it also includes full generator fluids, including fuel, engine oil and coolants.

Cargo Carrying Capacity (CCC): U.S. - Equal to the GVWR minus the UVW and LP gas weight. (Water is considered a component of cargo) Canada - Equal to GVWR minus the UVW, full fresh (potable) water weight (including the water heater) and full LP gas weight.

Gross Axle Weight Rating (GAWR): is the value specified as the load carrying capacity of a single axle system, as measured at the tire-ground interfaces.

Gross Vehicle Weight (GVW): is the weight of the coach with all the items and supplies that are loaded into the unit at any point in time.

Weighing your vehicle

First, locate a scale that will be large enough to weigh your trailer and tow vehicle. They are generally available at truck stops, concrete yards and grain elevators.

Before weighing your trailer, fill the propane tanks (80% capacity) and the fresh water tank if you plan on taking fresh water with you. Your tow vehicle should have a full tank of fuel and have all passengers included with the tow vehicle weight.

Pull onto the scales and locate the trailer in the center of the scale. block the wheels and unhitch the trailer making sure tongue jack or landing gears are set to level the trailer. Record the weight of the recreational trailer.

Hitch the trailer, raise the jacks and weigh both the trailer and the tow vehicle together. Record this weight.

Pull forward until tow vehicle is off the scales, then weigh trailer with axles on the scale. Record this weight. Subtract this weight from the trailer weight to find the hitch weight.

The Gross Vehicle Weight Rating (from the weight label) minus the recreational trailer weight equals the amount of supplies and personal gear you can carry.

If you have dual axles, you can get a weight for each axle by stopping on the scale with one axle on the scale and the other off. Record the weight of the one axle. Then move the trailer so that both of the axles are on the scale. Record this weight. The difference between the two axles will be the second axle's weight.

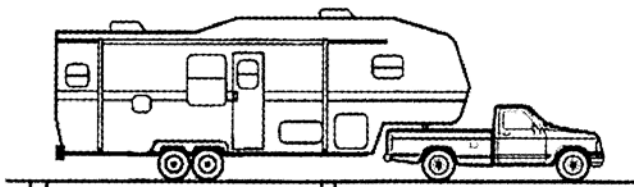

It is equally important that the load is distributed evenly among all of the axles and wheels. One axle or wheel may be overloaded even if the GVWR and GAWR weights are within limits.

Pull the trailer forward until the front axle is off of the scale. On tandem axle trailers, both axles should be carrying about the same load. If not, level the trailer or redistribute the load.



Also, check weight distribution at each wheel. Use the above technique weighing only the right or left side. Calculate the weight at each wheel. Be sure that no one wheel is overloaded. If you have trouble calculating or interpreting the weights, contact your dealer or vehicle manufacturer.

Weight Rating

Located on the unit's front roadside lower corner is a Federal Certification Label. This label gives the maximum weight carrying capacities of your unit and for each axle designated by the letters "GVWR" and "GAWR" respectively. The serial number of your unit is located on this label, also. Here is a sample label as found on the pin box:

RECREATION VEHICLE TRAILER CARGO CARRYING CAPACITY			
VIN: 5SFSG3424BE216986		DRY WEIGHT: 4573.2 Kg or 10082 Lbs.	
The weight of cargo should never exceed		1710.1 Kg or 3770 Lbs	
CAUTION:			
a full load of water equals		215 kg or 473 Lbs. of cargo @1 kg/L (8.3 lb/gal)	
MANUFACTURED BY/FABRIQUE PAR: HEARTLAND RECREATIONAL VEHICLES		DATE: 2/25/2010	
GVWR/PNBV		6305.0 Kg 13900 (LB)	
GAWR (EACH AXLE)/PNB (CHAQUE ESSEIU)		2721.6 Kg 6000 Lb TIRES/PNEU ST235/80/R16 E	
RIM/JANTE		16 x 6	
COLD INFL. PRESS./PRESS. DE GONFL. A F		552 KPA (80 PSI/LPC)	
THIS VEHICLE CONFORMS TO ALL APPLICABLE U.S. FEDERAL MOTOR VEHICLE SAFETY STANDARDS IN EFFECT ON THE DATE OF MANUFACTURE SHOWN ABOVE. THIS VEHICLE CONFORMS TO ALL APPLICABLE STANDARDS PRESCRIBED UNDER THE CANADIAN MOTOR VEHICLE SAFETY REGULATIONS IN EFFECT ON DATE OF MANUFACTURE. - CE VEHICULE EST CONFORME A TOUTES LES NORMES QUI LUI SONT APPLICABLES EN VERTU DU REGLEMENT SUR LA SECURITE DES VEHICLES AUTOMOBILES DU CANADA EN VIGUEUR A LA DATE DE SA FABRICATION			
V.I.N./N.I.V. 5SFSG3424BE216986 TYPE/TYPE: TRAILER / TRA / REM MODEL: 32RL Greystone			
TIRE AND LOADING INFORMATION RENSEIGNEMENTS SUR LES PNEUS ET LE CHARGEMENT			
The weight of cargo should never exceed			
1710.1 Kg or 3770 Lbs.			
CAUTION: a full load of water 215 kg 473 lbs of cargo @1kg/L(8.3 lb/gal)			
TIRE PNEU	SIZE DIMENSIONS	COLD TIRE PRESSURE PRESSION DES PNEUS A FROID	SEE OWNER'S MANUAL FOR ADDITIONAL INFORMATION VOIR LE MANUEL DE L'USAGER POUR PLUS DE RENSEIGNEMENTS
FRONT AVANT	ST235/80/R16 E	80 PSI / 552 KPA	
REAR ARRERE	ST235/80/R16 E	80 PSI / 552 KPA	
SPARE DE SECOURS	ST235/80/R16 E	80 PSI / 552 KPA	

Under no circumstances should the respective loads ever exceed these ratings. Dealer installed equipment will reduce CCC. If the loaded weight of your RV exceeds the GVWR or the weight of any axle exceeds that axle's GAWR, the RV is overloaded and you must remove items to bring the weight down to or below the GVWR or GAWR.

Pin Weight

To determine the pin weight of the vehicle, you must weigh the tow vehicle with the trailer hitched. Record this weight. Then disconnect the trailer and weigh the tow vehicle again. Subtract the difference between the two weights and you will arrive at your pin/hitch weight. Adjust your cargo accordingly to remain within 15-27% of the GVWR of the 5th wheel (10-15% on a Travel Trailer). The GVWR is the GAWR added to the pin/hitch weight.

Loading Instructions

Whether you start out for a weekend jaunt or a longer trip, the first thing you are going to do is load such items as food, clothing, bedding and recreational equipment. As you become experienced in RV living, you will learn what is necessary and what merely takes up storage space.

NOTICE

EMPTY ALL HOLDING TANKS BEFORE FILLING FRESH WATER TANK; OTHERWISE YOU WILL LIMIT CARGO CAPACITY. MOST CAMPGROUNDS SUPPLY DUMP STATIONS WHICH CAN BE UTILIZED.

Loading Tips

After you have determined how much weight you can safely carry and selected those items to make up that weight, make a list and keep it for future reference. Load the RV and distribute the load so that you get proper weight on the axles and hitch. Do not load upper cabinets with heavy items which can shift or fall during transit. Secure and brace items so they won't move during travel, thereby shifting the load in the RV. Do not load heavy items near either end of the RV or on the rear bumper. Adjust cargo storage to keep the side to side wheel loads as equal as possible. Carry only as much water as needed for travel use or to balance the load. **Always empty your waste water and sewage holding tanks before traveling.**

Make a loading diagram of your properly loaded RV. It will help you locate where specific items are stored and will help speed the loading process. Store emergency items in a readily accessible location. Include tools, first-aid kit, rain gear, flashlight, highway warning devices, and an electric cord or light.

All items must be considered for their weight and stored according to how heavy they are. Heavy items should be placed close to the floor and in the center of the vehicle. **DON'T FORGET TO INCLUDE THE ITEMS YOU PURCHASE ON YOUR TRIP.**

Luggage and similar cargo carried inside the vehicle must be secured to prevent possible damage in the case of a sudden stop or accident.

The amount and placement of cargo will also affect the amount of water and LP gas that you can carry. Water weighs 8.3 pounds per gallon and propane weighs 4.2 pounds per gallon. Periodically reweigh your unit. Different traveling configurations may change your loading and weight pattern.

Traveling

Towing – A good way to practice towing is to choose a large parking lot (where it is permissible).

Easing to a stop and starting smoothly saves wear and tear on your tow vehicle, saves gas, and prevents damage to the hitch and items stowed in the trailer. Remember, when towing the trailer, always maintain at least three cars and a trailer (approximately 85 ft) length space between you and the car in front of you for every 10 miles of speed that you are traveling. This should give you ample time to stop in case of emergency.

As you drive, try to anticipate problems that may occur and prepare for them, even though they may never happen. Anticipate dips, gutters and depressions in the street, slowing down well in advance, as these are the hardest jolts of any kind on your tow vehicle, your hitch, your trailer and items stored in your trailer. Take dips and bumps slowly and be certain that the trailer wheels have passed the point before accelerating. Cross railroad tracks slowly. Always release your brakes before crossing. On long grades, shift into a lower gear (or lower range, if you have automatic transmission) before your engine labors.

When going downhill, use the same procedure as going uphill well in advance; the compression of your tow vehicle's engine will help to slow your whole rig safely. Avoid conditions that require excessive and prolonged use of your brakes. Apply and release brakes at short intervals to give them a chance to cool.

Controlling Sway or Fishtailing

Sway or fishtailing is the sideways action of a trailer caused by external forces. It is common for travel trailers to sway in response to strong winds or crosswinds or when passed by or passing a semi-tractor and trailer or driving downhill.

Overtaking and Passing

When you pass another vehicle, remember that it takes longer to accelerate and you must allow for the length of the trailer to pass as well, before returning to your lane. Use your signals freely. On freeways and expressways, try to pick the lane in which you want to move and stay in it, preferably the slow lane to the right. Remember, always pass very carefully.

Slippery Pavement

On slippery and icy pavement, drive slowly, and if you feel you are skidding, gently apply the trailer brakes only.

Backing and Parking

After arriving at your destination, your next task is to choose a good level parking space and back into it. A recommended procedure for backing into a space is:

Stop near the site, get out and look it over. (Check the site for low hanging tree limbs, posts, large rocks, etc., which are to be avoided.)

Always try to place the site to your left. This way you can see what the trailer is doing while you are backing. If the site is on your right, you will be backing onto your blind side, which is more difficult.

With everything clear, maneuver the vehicle into position for backing into the site.

Now grasp the steering wheel at the bottom (never at the top) and back up. Turn the steering wheel in the direction you wish the vehicle to go. If the site is on your left, move your hand to the left and back slowly, watching the vehicle. When the vehicle starts into the turn, follow it by easing up on the steering wheel. The vehicle will move into position.

Once in site, pull vehicle forward & back again to prevent trailer from maintaining a binded position which can damage the trailer and components.

WHEEL NUT TORQUE

Proper wheel nut torque is essential to safe and dependable trailering. The wheel and axle systems used in RVs are similar in many ways to those used in cars and trucks, but they differ in several important ways. These differences require special attention to wheel nut torque both while the trailer is new and throughout the trailer's life

Trailer wheels must carry much higher loads per wheel than passenger car or truck wheels. Furthermore, wheels on tandem axle trailers do not steer, and are subjected to very high side load stress whenever the trailer makes a tight turn. When you go around corners – especially slow, tight ones – the wheels on your trailer are subjected to these strong side loads. This tends to flex the wheel and gradually loosen the wheel nuts. Although the materials and manufacturing methods are maximized for this kind of service, these extra load stresses and flexing can cause loosening.

It is critical that the wheels be properly torqued at the start of the trip and every 50 miles for the first 500 miles of road operation. Although the wheels have been properly torqued before leaving the manufacturing plant, settling and wearing in of components during the first few miles of operation may cause some loosening of the wheel nuts.

The wheel nut torque is 120 ft-lbs. Always use an accurate torque wrench to tighten wheel nuts. A torque wrench with adequate accuracy is available at most automotive tool stores. Considering the overall investment in the trailer, this is a very reasonable cost. Use of a torque wrench can also reduce the effort required to tighten the wheel nuts.

⚠ WARNING

IT IS IMPORTANT TO MAINTAIN PROPER TORQUE TO PROVIDE SAFE AND SECURE ATTACHMENT OF THE WHEEL TO THE HUB/DRUM. BE SURE TO USE WHEEL NUTS THAT ARE COMPATIBLE WITH THE COIN IN THE WHEEL. IMPROPERLY TORQUED WHEEL NUTS CAN CAUSE THE WHEEL TO SEPARATE FROM THE WHEEL MOUNTING SURFACE DURING OPEARTION. THIS COULD RESULT IN PROPERTY DAMAGE, SERIOUS PERSONAL INJURY, OR LOSS OF LIFE.

Any time a wheel is replaced, be sure to tighten the wheel nuts, following the sequence shown in the diagram to the specified torque. If the wheel was replaced, check the torque again at every 50 miles for the first 500 miles and prior to each trip thereafter. If you notice wheel wobbling or hear a rattling sound coming from a wheel, especially

at low speeds, a wheel lug nut may have come loose. This problem is usually caused by improper tightening or by faulty or damaged lug bolt threads. If you have reason to believe a lug nut has come loose, **SAFELY STOP THE VEHICLE AT THE SIDE OF THE ROAD AS SOON AS POSSIBLE.** Put up warning devices. Remove the lug caps and check the tightness of all the lug nuts.

Tighten all lug nuts to the specified torque of 120 ft-lbs. If lug bolt threads are damaged or faulty, get professional service help. Do NOT tow the trailer with missing lug nuts or faulty lug bolts.

⚠ WARNING

DO NOT USE A SIZE AND TYPE OF TIRE AND WHEEL OTHER THAN THAT ORIGINALLY PROVIDED BY HEARTLAND RECREATIONAL VEHICLES, LLC BECAUSE IT CAN AFFECT THE SAFETY AND PERFORMANCE OF YOUR VEHICLE, WHICH COULD RESULT IN AN INCREASED RISE OF LOSS OF VEHICLE CONTROL, VEHICLE ROLLOVER AND/OR SERIOUS PERSONAL INJURY OR DEATH. THE INSTALLATION OF INCORRECT WHEELS COULD CAUSE WHEEL SEPARATION WHICH COULD RESULT IN PROPERTY DAMAGE, SERIOUS PERSONAL INJURY, OR LOSS OF LIFE.

1. Clean mounting surfaces, lug nuts & studs. Do no lube lug joint unless instructed in your owner's manual.
2. Start all lug nuts by hand to prevent cross threading.
3. Tighten nuts in sequence shown below using a calibrated torque wrench. Do not use an impact wrench. Wheel nut torque requirements vary depending on the size and manufacturer. Always use wheel manufacturer's recommendations
4. Wheel nuts should be torqued before first road use and after each wheel removal. Periodically check and re-torque per manufacturer's recommendations.

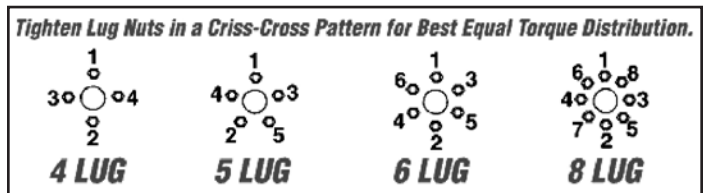

⚠ WARNING

DO NOT TOW THE TRAILER WITH MISSING LUG NUTS OR FAULTY LUG BOLTS

Before each trip and any time a wheel is replaced, be sure to tighten the wheel nuts, following the sequence shown in the relevant lug pattern below. Set the torque specification in three stages as seen in the chart below. If the wheel was replaced, check the torque every 50 miles of the first 200 miles of travel.

If you notice wheel wobbling or hear a rattling sound coming from a wheel, especially at low speeds, a wheel lug nut may have come loose. This problem is usually caused by improper tightening or by faulty or damaged lug bolt threads. If you have a reason to believe a lug nut has come loose, safely stop the vehicle at the side of the road as soon as possible. Put up warning devices. Remove the lug caps and check the tightness of all the lug nuts. Tighten all lug nuts to the specified torque, using a torque wrench. If lug stud threads are damaged or faulty, get professional service help.

 WARNING
DO NOT MISMATCH WHEELS AND TIRES

Wheel Compatibility

 WARNING
WHEEL SEPARATION CAN OCCUR
<ol style="list-style-type: none">1. ON FIRST TRIP, TIGHTEN WHEEL LUGS AT START AND AT 10, 25, AND 50 MILES. TIGHTEN TO MANUFACTURER'S SPECIFICATIONS AS OUTLINED IN THE OWNER'S MANUAL.2. THEREAFTER, CHECK WHEEL LUGS BEFORE EACH TRIP.3. FOLLOWING WINTER STORAGE, CHECK BEFORE BEGINNING A TRIP.4. FOLLOW EXCESSIVE BRAKING, INSPECT WHEEL LUGS.
AR0062

Axle systems are installed with hubs and drums that are compatible with many wheels used in the recreational vehicle industry that have matching bolt patterns. If the original manufacturer installed equipment is in need of replacement, the wheel manufacturer should be contacted for proof of compatibility prior to replacement and use.

Customers replacing original equipment that has not been tested for compatibility must ensure the replacements are compatible to the hub and drum assembly installed. Such elements of compatibility include, but are not limited to:

- Diameter of the hub-mounting surface.
- Stud length and diameter.
- Location and number of studs.
- Center hold diameter for the wheel.
- Wheel mounting offset from the rim center.
- Rated capacity of the wheel.
- Wheel fastener torque.
- Wheel nut size and shape.



Impact of any added wheel accessories (such as decorative center caps) that could affect proper seating of the wheel to the hub surface.

Certain tests are recommended by the manufacturer's of factory installed equipment, such as the cornering fatigue test based on SAE J1095/SAE J267 and field tests, are recommended for all wheels and rims to be installed in place of original factory equipment. Contact the wheel manufacturer to verify compatibility with the factory installed equipment prior to replacement.

TIRES & BRAKING

Tire Inspection

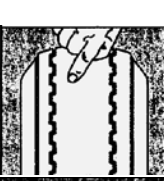
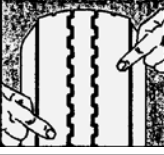
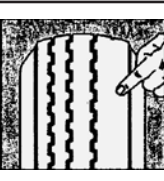
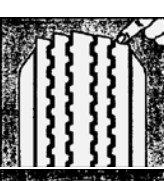
The following chart is meant to be helpful in determining the condition and maintenance of your tires:

	Condition	Possible Cause	Remedy
	Even Center Wear	Over Inflation	Check & Adjust Pressure When Cold
	Inside & Outside Wear	Under Inflation	Check & Adjust Pressure When Cold
	Smooth Side Wear – One Side	Loss of Camber or Overloading	Check & Unload As Necessary Have Alignment Checked
	“Feathering” Across The Face	Axle Not Square To Frame or Incorrect Toe In	Square Axles Have Alignment Checked
	Cupping	Loose Bearings or Wheel Balance	Check Bearing Adjustment and Wheel & Tire Balance
	Flat Spot	Wheel Lockup	Adjust Brakes

WARNING

WHEN REPLACING TIRES CONSULT THE WHEEL AND TIRE MANUFACTURERS' SPECIFICATIONS FOR COMPATIBILITY. IMPROPERLY MATCHED WHEELS AND TIRES MAY FAIL AND CAUSE PROPERTY DAMAGE, SERIOUS PERSONAL INJURY, OR LOSS OF LIFE.

Wheel Bearing Lubrication

There is no need to lift the vehicle before greasing axles equipped with today's modern “easy-lube” technologies: Remove the rubber plug from grease cap. Insert grease gun on the grease zerk. Pump until new grease begins to appear. Replace rubber plug.

Hubs and components should also be disassembled yearly and inspected for worn or otherwise damaged parts.

Home is where your heart is...

WARNING

KEEP TIRES PROPERLY INFLATED. A TIRE THAT IS RUN LONG DISTANCES OR AT HIGH SPEEDS WHILE SERIOUSLY UNDERINFLATED WILL OVERHEAT TO THE POINT WHERE THE TIRE MAY LOSE AIR SUDDENLY AND/OR CATCH FIRE, POSSIBLY RESULTING IN DAMAGE TO THE VEHICLE AND ITS CONTENTS AND OR PERSONAL INJURY.

Tires and Wheels

The tires should be checked before starting on every trip. Check them regularly and keep inflated to recommended pressures. The recommended tire pressure is on the side of the tire. Rotate tires at least once every 5,000 miles or as recommended by the tire manufacturer. Most models have a spare tire available in case of an emergency.

All vehicles are equipped with tubeless tires. They are designed for today's turnpike speeds and are rated to carry the weight of the trailer plus your family's personal needs for an extended vacation. If you should require an adjustment on a faulty or defective tire, secure the name of your nearest tire dealer or distributor and request an adjustment according to the conditions and terms of the warranty.

Tire Changing

1. Use emergency flares when near a road or highway.
2. Block wheels on the opposite side from the tire you wish to change to prevent accidental movement.
3. Position a hydraulic jack on the frame close to the spring hanger.
4. Raise the trailer until the tire clears the ground.

WARNING

CHECK TIRE PRESSURES BEFORE TRAVELING. ALWAYS CHECK TIRE PRESSURE WHEN TIRES ARE COLD. DO NOT EXCEED THE MAXIMUM RECOMMENDED PRESSURE.

The Importance of Proper Tire Inflation

Your trailer tires and wheels, and tongue or fifth-wheel hitch, support the entire weight of the trailer and its contents. The tires are also the only contact the trailer has with the road surface. Determining and maintaining proper inflation is the most important factor in maximizing the life of your tires. Driving on a tire that does not have the correct inflation pressure for the trailer load is dangerous and may cause premature wear, tire damage, tread delaminating and/or loss of control of the trailer and/or tow vehicle.

An under-inflated tire will build up excessive heat that may go beyond the limits of the tire materials. This could result in sudden tire failure. An under-inflated tire will also cause poor vehicle handling, rapid and/or irregular tire wear, and an increase in rolling resistance which results in decreased tow vehicle fuel economy.

The maximum cold inflation pressure for your tires is stated on the tire sidewalls. Keep your tires inflated to the maximum cold pressure. This reduces the chance of a failure and improves towing stability. Maintaining correct tire inflation pressure for your trailer is of the utmost importance and must be a part of regular vehicle maintenance.

You must weigh your trailer when it is fully loaded as you expect to use it. You need to weigh all axles together and calculate the hitch weight. You may find that even though the total weight is within the GVWR, one side may be overloaded. For this reason, you must know the weight of each side of the trailer. When you know the weight on each side of the trailer, the combined axle assembly, and the hitch weight, you will be able to manage your loading to be able to maintain good balance and assure good and safe handling on the road. Here are some tips to help you plan your loading:

- Do not overload. Experiment with various loads starting with light loads and working up to heavier loads. Take into consideration the load of the fresh water system. The tow vehicle and the terrain will affect the true weight you should carry.
- Distribute the load evenly over the axles as much as possible. Keep heavy items low and forward, preferably in the lower storage areas. This will produce a lower center of gravity, and improve road stability.
- Distribute the load evenly on each side of the trailer. Place heavier object opposite the heavier appliances, cabinets, furniture, etc. when possible. Experiment with various load positions until you find the best distribution.
- Avoid loading heavy items in or on the rear of the trailer. This can cause both total weight problems and hitch weight distribution problems.
- Secure items so they won't move around while traveling. Make sure all items and materials are properly stored. Close and latch all drawers, cabinet doors, and closet doors. Pull all loose furniture away from cabinets and walls, and lie on their side or secure to prevent rubbing during travel.
- Carry only as much water as you think you will need while traveling. Water weighs over eight pound per

gallon. Whenever possible, empty the holding tanks before going on the road.

- If you are heading for rough terrain, use heavy packing material in the cupboards to hold plates, glasses, etc. Put a nonskid material beneath heavier items to prevent shifting. Expensive and breakable belongings should be well packed and placed on the floor in the center of the trailer, as the center rides best.
- Store emergency items, such as fire extinguisher, first-aid kit, highway warning devices, gloves, etc. in a readily accessible place. Do not bury these items beneath other cargo.
- When you have properly loaded your trailer with the things you need for your trip, make a diagram that outlines where things are stored. With this diagram, your list of items and the weight of the items, you will be able to find specific items easily and have a hand reference for determining proper weights.
- Weigh your trailer after you have loaded it. You have to do this several times to get it right.

 CAUTION
TIRE LOAD RATINGS ARE DEPENDENT ON TIRE INFLATION PRESSURES. UNDER-INFLATED TIRES CAN BE DAMAGED AND RESULT IN A LOSS OF INFLATION PRESSURE.

Check the trailer tires frequently. Tires can lose air over a period of time. In fact, tires can lose 1 to 3 PSI per month. This is because molecules of air, under pressure, migrate through the rubber from the inside to the outside. A drop in tire pressure could cause the tire to become overloaded, leading to excessive heat buildup. If a trailer tire is under-inflated, even for a short period of time, the tire could suffer internal damage. A flat can go unnoticed on a multiple axle trailer while it is being towed. Running with a flat can cause it to catch fire and burn up your rig. With multiple axles or tandem wheels it is hard sometimes to see a flat tire as the other tires are supporting the weight of the rig and the flat tire is less noticeable. A quick check can be made by "thumping" each tire with a tire iron or rod to make sure they all sound the same. Each time you gas up, walk around the trailer and give a quick check by feeling each tire with your hand. A tire that is getting low will be hotter than the rest. There is no substitute, however, for actually measuring tire pressures to make sure they are all within safe limits. Always check the cold tire inflation pressures before each trip and at least once a week during the trip for proper inflation levels.

The most common causes of tire failure are overloading and underinflation. Both result in excess flexing of the tire sidewall which causes heat buildup and eventual tire failure. **Continuing to run with a flat can cause it to catch fire.**

The most important things you can do to avoid tire fires are:

- Maintain proper tire pressure
- Stay within tire and vehicle road limits
- Avoid road hazards if possible
- Inspect tires for cuts, slashes, and other irregularities.

Properly maintained tires improve the steering, stopping, traction, and load-carrying capability of your vehicle. Make tire safety a regular part of your vehicle maintenance routine. Recognize that the time you spend is minimal compared with the inconvenience and safety consequences of a flat tire or other tire failure.

Understanding Tire Pressure and Load Limits

Tire inflation pressure is the level of air in the tire that provides it with load-carrying capacity and affects the overall performance of the vehicle. The tire inflation pressure is a number that indicates the amount of air pressure a tire requires to be properly inflated. It is difficult to obtain the recommended tire pressure if your tires are not cold. Because tires are designed to be used on more than one type of vehicle, tire manufacturers list the “maximum permissible inflation pressure” on the tire sidewall. This number is the greatest amount of air pressure that should ever be put in the tire under normal driving conditions.

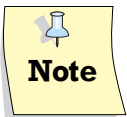

Note

The air pressure recommended on the tire information placard is for the original standard equipment tires only. Your trailer may be equipped with optional-sized tires. Always follow the pressure recommendations stamped on the tire sidewall for any replacement tire.

Checking and Adjusting Tire Pressure

It is important to check your vehicle’s tire pressure at least once a month, always before each trip, and at least once a week while on the road. Not only do tires naturally lose pressure over time, but they can lose air suddenly if you drive over a pothole or other object, or if you strike the curb. It is difficult to determine tire inflation pressure by looking at the tire. Purchase a tire pressure gauge to keep in your vehicle. Gauges can be purchased at tire dealerships, auto supply stores and other retail outlets.

Home is where your heart is...

The recommended tire inflation pressure that vehicle manufacturers provide reflects the proper psi when a tire is cold. A “cold” tire is one that has not been driven on for at least three hours. When you drive, your tires get warmer, causing the air pressure within them to increase. Therefore, to get an accurate tire pressure reading, ***you must measure tire pressure when the tires are cold.***

Refer to the tire’s sidewalls for the recommended tire pressure. Your trailer may be equipped with optional tires.

Check and write down the pressure in all tires.

If the tire pressure is too high in any of the tires, slowly release air by gently pressing on the tire valve stem with the edge of your tire gauge until you get to the correct pressure.

If the tire pressure is too low, note the difference between the measured tire pressure and the correct tire pressure. You will need to add air to get to the correct pressure.

Add air pressure to each tire that is under-inflated.

Check all the tires again to make sure they have the same air pressure.

If you have been towing your trailer and think that a tire is under-inflated, fill it to the recommended cold inflation pressure. Remember to recheck and adjust the pressure in all tires when you can obtain a cold reading.

Tire Tread

The tire tread provides the gripping action and traction that prevent your vehicle from slipping or sliding, especially when the road is wet or icy. In general, tires are not safe and should be replaced when the tread is worn down to 1/16 of an inch. Tires have built-in tread-wear indicators that let you know when it is time to replace your tires. These indicators are raised sections spaced intermittently in the bottom of the tread grooves. When they appear “even” with the outside of the tread, it is time to replace your tires.

Tire Life

Trailer tires may be worn out even though they still have plenty of tread left. This is because trailer tires have to carry a lot of weight all the time, even when not in use. It is actually better for a tire to be rolling down the road than to be idle. During use, the tire releases lubricants that are beneficial to tire life. Using the trailer tires often also helps prevent flat spots from developing.

The average life of a trailer tire is about five years under normal use and maintenance conditions. After five years, trailer tires may be degraded to the point that they should be replaced, even if they have had minimal or no use. Exposure to sunlight (ultra-violet damage) and high speed towing in hot conditions also reduces tire life. As heat builds up during driving, the tire's internal structure starts to break down, compromising the strength of the tire. Have your tires inspected by a tire supplier to determine if your tires need to be replaced.

 WARNING
ALL TIRES ON YOUR TRAILER SHOULD BE THE SAME TYPE, SIZE, CONSTRUCTION AND LOAD RATING – DO NOT MIX BIAS-BELTED AND RADIAL TIRES.

Replacement Tires

To maintain tire safety, purchase new tires that are the same type, size, construction and load ratings as the original tires. Look at the tire Information placard, or the sidewall of the tire you are replacing to find this information. If you have any doubt about the correct size to choose, consult with the tire dealer.

 WARNING
THERE IS A DANGER OF SERIOUS INJURY OR DEATH IF A TIRE OF ONE BEAD DIAMETER IS INSTALLED ON A RIM OR WHEEL OF A DIFFERENT RIM DIAMETER. ALWAYS REPLACE A TIRE WITH ANOTHER TIRE OF EXACTLY THE SAME BEAD DIAMETER DESIGNATION AND SUFFIX LETTERS.

Tire Safety Information

This portion of the Owner's Manual contains tire safety information as required by 49 CFR 575.6

The National Highway Traffic Safety Administration (NHTSA) has published a brochure (DOT HS 809 36) that discusses all aspects of Tire Safety, as required by CFR 575.6. It can be obtained and downloaded from NHTSA, free of charge, from the following web site:

http://www.NHTSA.dot.gov/cars/rules/TireSafety/ridesonit/tires_index.html

Studies of tire safety show that maintaining proper tire pressure, observing tire and vehicle load limits (not carrying more weight in your vehicle than your tires or vehicle can safely handle), avoiding road hazards, and inspecting tires for cuts, slashes, and other irregularities

are the most important things you can do to avoid tire failure, such as tread separation or blowout and flat tires.

These actions, along with other care and maintenance activities, can also:

- Improve vehicle handling
- Help protect you and others from avoidable breakdowns and accidents
- Improve fuel economy
- Increase the life of your tires.

Use this information to make tire safety a regular part of your vehicle maintenance routine. Recognize that the time you spend is minimal compared with the inconvenience and safety consequences of a flat tire or other tire failure.

Safety First – Basic Tire Maintenance

Properly maintained tires improve the steering, stopping, traction, and load-carrying capability of your vehicle. Under-inflated tires and overloaded vehicles are a major cause of tire failure. Therefore, as mentioned above, to avoid flat tires and other types of tire failure, you should maintain proper tire pressure, observe tire and vehicle load limits, avoid road hazards, and regularly inspect your tires.

Finding Your Vehicle's Recommended Tire Pressure and Load Limits

Tire information placards and vehicle certification labels contain information on tires and load limits. These labels indicate the vehicle manufacturer's information including:

- Recommended tire size
- Recommended tire inflation pressure
- Vehicle capacity weight (VCW—the maximum occupant and cargo weight a vehicle is designed to carry)
- Front and rear gross axle weight ratings (GAWR—the maximum weight the axle systems are designed to carry).

Both placards and certification labels are permanently attached to the trailer on the forward half of the left side, and are easily readable from outside the vehicle without moving any part of the vehicle.

Tire Repair

The proper repair of a punctured tire requires a plug for the hole and a patch for the area inside the tire that surrounds the puncture hole. Punctures through the tread can be repaired if they are not too large, but punctures to the sidewall should not be repaired. Tires must be removed from the rim to be properly inspected before being plugged and patched.

Tire Fundamentals

Federal law requires tire manufacturers to place standardized information on the sidewall of all tires. This information identifies and describes the fundamental characteristics of the tire and also provides a tire identification number for safety standard certification and in case of recall.

Tire Label Information

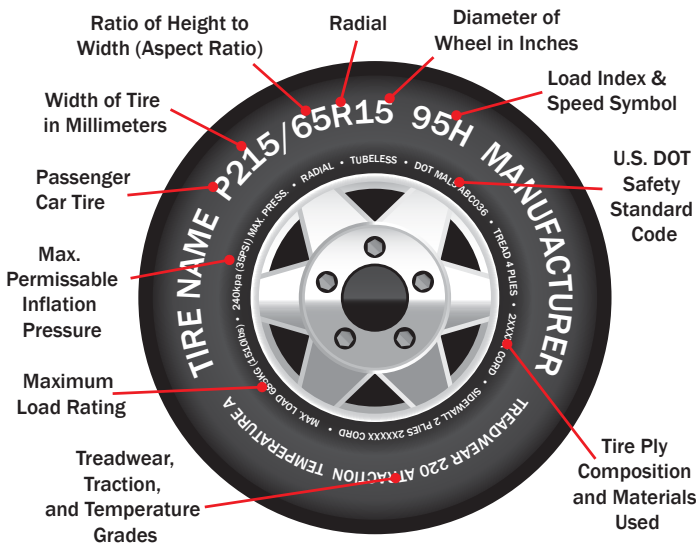

NOTICE

YOUR TRAILER IS EQUIPPED WITH TIRES DESIGNATED AS "ST". THIS DESIGNATION MEANS THAT THE TIRES ARE BUILT SPECIFICALLY FOR TRAILER APPLICATIONS. THEY ARE CORRECT FOR YOUR TRAILER AND THE MAXIMUM LOADS THE TRAILER WAS DESIGNED AND RATED TO CARRY.

TIRE INDUSTRY STANDARDS REQUIRE THAT TIRES WITH "ST" DESIGNATION ARE SPEED RESTRICTED TO 65 MPH UNDER NORMAL INFLATION AND LOAD CONDITIONS. UNLESS A DIFFERENT SPEED RESTRICTION IS INDICATED ON THE SIDEWALL OF THE TIRE, IT IS BEST THAT YOU DO NOT OPERATE YOUR TRAILER AT SPEEDS ABOUT 65 MPH.

P - The "P" indicates the tire is for passenger vehicles.
NOTE: Passenger car tires are not recommended for use on trailers.

LT - The "LT" indicates the tire is for light trucks or trailers.

NOTICE

ALTHOUGH TIRES DESIGNATED "LT" ARE SOMETIMES USED ON TRAILERS, THEY ARE NOT RECOMMENDED FOR USE ON YOUR TRAILER AND SHOULD NOT BE CONSIDERED AS REPLACEMENTS FOR THE ORIGINAL EQUIPMENT "ST" DESIGNATED TIRES.

ST - An "ST" is an indication the tire is for trailer use only

Next number - This three-digit number gives the width in millimeters of the tire from sidewall edge to sidewall edge. In general, the larger the number, the wider the tire.

Next number - This two-digit number, known as the aspect ratio, gives the tire's ratio of height to width.

R - The "R" stands for radial. Other tire designs may be "bias ply" or "bias belted" and are designated by other letters.

Next number - This two-digit number is the wheel or rim diameter in inches. If you change your wheel size, you will have to purchase new tires to match the new wheel diameter.

Next number - This two- or three-digit number is the tire's load index. It is a measurement of how much weight each tire can support. You may find this information in your owner's manual. If not, contact a local tire dealer.

Note: You may not find this information on all tires because it is not required by law.

Speed Rating - The speed rating denotes the speed at which a *passenger car* tire is rated. A speed rating will not be found on "ST" tires used on trailers. All "ST" tires are speed restricted to 65 mph. Never operate a vehicle in an unsafe or unlawful manner. Tire speed ratings (if indicated) should never be associated with the ability of the vehicle to handle the speed for which the tire is rated.

U.S. DOT Tire Identification Number

This begins with the letters “DOT” and indicates that the tire meets all federal standards. The next two numbers or letters are the plant code where it was manufactured, and the last four numbers represent the week and year the tire was built. For example, the numbers 3197 means the 31st week of 1997. The other numbers are marketing codes used at the manufacturer’s discretion. This information is used to contact consumers if a tire defect requires a recall.

Tire Ply Composition and Materials Used

The number of plies indicates the number of layers of rubber-coated fabric in the tire. In general, the greater the number of plies, the more weight a tire can support. Tire manufacturers also must indicate the materials in the tire, which include steel, nylon, polyester, and others.

Maximum Load Rating

This number indicates the maximum load in kilograms and pounds that can be carried by the tire.

Maximum Permissible Inflation Pressure

This number is the greatest amount of air pressure that should ever be put in the tire under normal driving conditions.

Vehicle Load Limits

Determining the load limits of a vehicle includes more than understanding the load limits of the tires alone. A Federal Certification Label is located on the forward half of the left (road) side of the unit. The certification label will indicate the vehicle’s gross vehicle weight rating (GVWR). This is the most the fully loaded vehicle can weigh. It also provides the gross axle weight rating (GAWR). This is the maximum weight a particular axle can carry. If there are multiple axles, the GAWR of each axle will be provided. In the same location as the certification label described above, there is a vehicle placard. This placard provides tire and loading information. In addition, this placard will show a statement regarding maximum cargo capacity.

Cargo Capacities

Cargo can be added to the vehicle, up to the maximum weight specified on the placard. The combined weight of the trailer and cargo is provided as a single number. In

any case, remember: ***The total weight of a fully loaded vehicle can not exceed the stated GVWR.***

Water and propane also need to be considered. The weight of fully filled propane containers is considered part of the weight of the RV before it is loaded with cargo and is not considered part of the disposable cargo load. Water however, is a cargo weight and is treated as such. If there is a fresh water storage tank of 100 gallons, this tank when filled would weigh about 800 pounds. If more cargo is being transported, water can be off-loaded to keep the total amount of cargo added to the vehicle within the limits of the GVWR so as not to overload the vehicle.

Understanding this flexibility will allow you, the owner, to make choices that fit your travel and camping needs.

When loading your cargo, be sure it is distributed evenly to prevent overloading front to back and side to side. Heavy items should be placed low and as close to the axle positions as reasonable. Too many items on one side may overload a tire. The best way to know the actual weight of the vehicle is to weigh it at a public scale. Talk to your RV dealer to discuss the weighing methods needed to capture the various weights related to the RV. This would include weights for the following: axles, wheels, hitch or pin (in the case of a trailer) and total weight.

How Overloading Affects Your RV and Tires

The results of overloading can have serious consequences for passenger safety. Too much weight on your vehicle’s suspension system can cause spring, shock absorber, or brake failure, handling or steering problems, irregular tire wear, tire failure or other damage. An overloaded vehicle is hard to drive and hard to stop. In cases of serious overloading, brakes can fail completely, particularly on steep hills. The load a tire will carry safely is a combination of the size of tire, its load range, and corresponding inflation pressure. Excessive loads and/or under-inflation cause tire overloading and, as a result, abnormal tire flexing occurs. This situation can generate an excessive amount of heat within the tire. Excessive heat may lead to tire failure. It is the air pressure that enables a tire to support the load, so proper inflation is critical. Since RVs can be configured and loaded in many ways, air pressures must be determined from actual loads (determined by weighing) and taken from the load and inflation tables provided by the tire manufacturer. These air pressures may differ from those found on the certification label. However, they should never exceed the tire limitation for load or air pressure. If you discover that your tires cannot support the actual weights, the load will need to be lightened.

Tire Safety Tips

Preventing Tire Damage

- Slow down if you have to go over a pothole or other object in the road.
- Do not run over curbs or other foreign objects in the roadway, and try not to strike the curb when parking.

Tire Safety Checklist

- Check tire pressure (including the spare) at least once a month and before going on any trip.
- Inspect tires for uneven wear patterns on the tread, cracks, foreign objects, or other signs of wear or trauma.
- Remove bits of glass and foreign objects wedged in the tread.
- Make sure your tire valves have valve caps.
- Do not overload your vehicle. Check the Tire Information and Loading Placard or User's Manual for the maximum recommended load for the vehicle.

Steps for determining correct load limit

- Locate the statement "The weight of cargo should never exceed XXX KG or XXX LBS" on your vehicles placard.
- The figure stated on the placard is the available amount of cargo load capacity
- Determine the weight of cargo being loaded in the vehicle. That weight may not safely exceed the available cargo capacity.

For further information about wheel and tire safety:

1-888-327-4236 (TTY: 1-800-242-9 53)

<http://www.safercar.gov>

and NHTSA

400 Seventh St. S.W.

Washington, DC 20590

Storage of Tires

Rubber tires degrade faster when not being used. A cool, dry, sealed garage is the preferred storage location. Many recreational vehicles are stored outside. Some storage surfaces may cause tires to prematurely age. Placing a barrier (plastic or plywood) between the tire and storage floor/ground helps to protect the tires. When the tire may be out of service for 30 days or more, the vehicle should be in long-term storage condition.

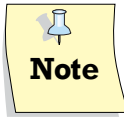
 <p>Note</p>	<p>IF THE RECREATIONAL VEHICLE IS STORED WITH WEIGHT ON THE TIRES, INFLATE THEM TO MAXIMUM INFLATION PRESSURE AS INDICATED ON THE FEDERAL IDENTIFICATION TAG.</p>
--	--

- Thoroughly clean the tires.
- Unload the vehicle so there is minimum weight on the tires.
- Ensure the surface is reasonably level, firm, clean and has good drainage.
- Move recreational vehicle every three months to prevent cracking in bulge areas as well as flat spotting from prolonged sidewall strain and tread deflection.
- Cover the tires to block direct sunlight and ultraviolet rays.
- The parking surface will affect moisture accumulation on the chassis and flooring.
- Gravel covered parking areas allow moisture to evaporate into the underside of the recreational vehicle.
- Sealed concrete pads allow better ventilation under the recreational vehicle.
- Storage buildings with sealed concrete floors or heated facilities greatly reduce the amount of moisture accumulation and protect the recreational vehicle from moisture damage.
- Avoid wet or greasy surfaces. Avoid highly reflective surfaces like asphalt, sand or snow.

Before removing the vehicle from long-term storage, thoroughly inspect each tire tread area and air pressure. In the pressure check indicates tires have lost air, inflate to correct pressure for current load before use.

Support Tires When Leveling

Extreme caution must be taken to ensure the tires are fully supported when placing blocks under the tires. The load on the tire should be evenly distributed on the support block. In case of dual tires, distribute the load evenly on blocks for both tires. If not properly supported, the steel cables in the sidewall of the tires may be damaged and could lead to premature fatigue of the sidewall.

 CAUTION
SUPPORTING TIRES PREVENTS DAMAGE TO THE SIDEWALL OF THE TIRES, BUT DOES NOT PREVENT TIRE ROLL.

In Case of Flat Tire

In the event of a flat tire, it is recommended to call for roadside assistance. The size and weight of the trailer requires the proper equipment to change the tire. A professional service technician will have the equipment and training necessary to repair or replace the tire. In the event of sudden tire failure, avoid heavy braking. Slowly move to a safe, off-road location, which should

be a firm, level area. Turn the hazard flasher system on. Inform roadside assistant of proper wheel mounting procedures.

WARNING

IN CASE THE TRAILER REQUIRES TOWING, ENSURE ALL PRECAUTIONS ARE FOLLOWED. THE MANUFACTURER WILL NOT COVER DAMAGE TO THE TRAILER CAUSED BY A TOWING COMPANY. NEVER ALLOW ANYONE TO GO UNDER A TRAILER WHILE IT IS BEING LIFTED BY TOWING EQUIPMENT. SERIOUS INJURY OR LOSS OF LIFE COULD RESULT.

Electric Brake System

The electric brakes on your vehicle are similar to those in your automobile; the difference being that they are activated by 12 volt electrical impulse as opposed to a hydraulic system. The impulse comes from a brake controller, which in effect regulates the flow of electrical current to the trailer brakes.

Brakes are usually maintenance free; however, road and driving conditions may at times cause them to grab, drag, or fade. Also, improper grounding of the trailer to the tow vehicle, irregular current, or a short circuit in the wiring system will cause electric brakes to malfunction. In any case, we strongly recommend that you consult your dealer or local trailer brake specialist on these problems.

WARNING

IF ANY KIND OR DEGREE OF BRAKE FAILURE OCCURS, HAVE THE BRAKES REPAIRED IMMEDIATELY. CONTINUED DRIVING IS DANGEROUS AND COULD RESULT IN SERIOUS INJURY OR LOSS OF LIFE.

Electric brakes should be checked prior to every trip to determine the condition of the magnets and drums, and whether wiring connections are still secure (see manufacturer's instructions). Brakes can be adjusted to activate ahead of the tow vehicle brakes for best road control. Consult the manufacturer's instructions or you dealer for detailed information and service procedures.

Synchronization of Brakes

Recreational vehicle brakes are designed to work in synchronization with tow vehicle brakes. Never use tow vehicle or recreational vehicle brakes alone to stop the combined load. The recreational vehicle and tow vehicle will seldom have correct amperage flow to the brake magnets to give comfortable, safe braking unless proper brake system adjustments are made. Changing

the recreational vehicle load and driving conditions, as well as uneven alternator and battery output, can mean unstable current flow to brake magnets. It is imperative to maintain and adjust brakes as set forth in this manual, use properly modulated brake controller and perform the synchronization procedure noted below.

In addition to the synchronization adjustments, electric brake controllers provide a modulation function that varies the current to the electric brakes with the pressure on the brake pedal or amount of deceleration of the tow vehicle. It is important that the brake control provide about 2 Volts to the braking system when the brake pedal is first depressed and gradually increases the voltage to 12 Volts as brake pedal pressure is increased. If the controller "jumps" immediately to high voltage output, even during a gradual stop, the electric brakes will always be fully energized and will result in harsh brakes and potential wheel lock-up.

Proper synchronization of tow vehicle to recreational vehicle braking can only be accomplished by road testing.

Brake lock-up, grabbing or harshness is often due to the lack of synchronization between the tow vehicle and the recreational vehicle being towed, too high of a threshold voltage (over 2 Volts) or under adjusted brakes.

Before synchronization adjustments are made, the recreational vehicle brakes should be burnished in by applying the brakes 2 or 3 times with about a 20 mph decrease in speed, e.g. 40 mph to 20 mph – Allow ample time for brakes to cool between applications, letting brake shoes and magnets slightly wear-in to drum surfaces.

Controllers

To ensure safe brake performance and synchronization, completely read the brake controller manufacturer's instructions before attempted synchronization procedure. Make several hard stops from 20 mph on a dry paved road, free of sandy and gravel. If the recreational vehicle brakes lock immediately, decrease gain setting on the controller. If they do not approach progressive lock-up slightly increase the gain setting.

WARNING

ROAD TEST BEFORE USING. BE SURE AREA IS CLEAR OF TRAFFIC AND PEDESTRIANS. DO NOT EXCEED 30 M.P.H. FOLLOW PROCEDURES OUTLINED BY THE CONTROLLER MANUFACTURER. FAILURE TO DO SO COULD RESULT IN PROPERTY DAMAGE, SERIOUS PERSONAL INJURY, OR LOSS OF LIFE.

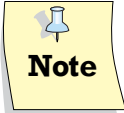

Note

MINIMUM VEHICLE STOPPING DISTANCES ARE ACHIEVED WHEN WHEELS APPROACH LOCK-UP. AVOID BRAKE LOCK-UP AS IT RESULTS IN POOR VEHICLE STABILITY AND CONTROL. DEPENDING ON THE LOAD, BRAKE TYPE, WHEELS AND TIRES, NOT ALL RECREATIONAL VEHICLE BRAKES ARE CAPABLE OF WHEEL LOCK-UP.

If the controller is applying recreational vehicle brakes before the tow vehicle brakes, adjust controller level so the recreational vehicle brakes comes on in synchronization with the tow vehicle brakes. Adjust controller to allow recreational vehicle brakes to come on just slightly ahead of the tow vehicle brakes. When proper synchronization is achieved there will be no sensation of the recreational vehicle jerking or “pushing” the tow vehicle during braking.

Start by making sure the recreational vehicle brakes are properly adjusted. Some controllers have a gain control to vary the amount of current to the brakes and a level control which sets the controller inertia sensor to sense deceleration. The level adjustment can also vary when the recreational vehicle braking is felt. Gain, or output control, adjustment usually controls maximum amount of amperage available to the brakes. This can be adjusted for varying recreational vehicle load.

⚠ CAUTION
DO NOT ADJUST THIS CONTROL OUTSIDE THE PARAMETERS OUTLINED BY THE BRAKE CONTROLLER MANUFACTURER’S INSTRUCTIONS.

Brake Adjustment

Brakes should be adjusted by a service dealer after the first 200 miles of operation when the brake shoes and drums have seated, at 3,000 mile intervals, or as use performance requires. The electric brakes are of the drum and two shoe type and adjust the same as most automotive drum brakes. The adjusting screw is accessible through a hole at the bottom of the backing plate. Remove the hole plug and use a standard brake adjusting tool. Turn the screw until the shoes contact the drum and with enough force to make the wheel hard to turn by hand. Then back off the screw ¼ to one full turn or until the wheel turns freely.

Brake Cleaning and Inspection

The recreational vehicle brakes must be inspected and serviced yearly, or more often. Magnets and shoes must be changed when they become worn or scored. Wear or scoring may inhibit vehicle braking. Clean the backing plate, magnet arm, magnet and brake shoes. Make sure

Home is where your heart is...

that all the parts are removed and replaced in the same brake and drum assembly. Inspect the magnet arm for any loose or worn parts. Check shoe return springs. Hold down the springs and the adjuster springs to check for stretch or deformation. Replace if necessary.

⚠ CAUTION
SOME BRAKE SHOE FRICTION MATERIALS CONTAIN ASBESTOS. CERTAIN PRECAUTIONS MUST BE TAKEN WHEN SERVICING BRAKES: AVOID CREATING OR BREATHING DUST; AVOID MACHINING, FILING OR GRINDING THE BRAKE LINING; DO NOT USE COMPRESSED AIR OR DRY BRUSHING FOR CLEANING. (DUST CAN BE REMOVED WITH A DAMP BRUSH.)

Maintain Safe Braking Distance

Braking action involves *perception time* and *reaction time*. First a person has to decide to push on the brake pedal. That is *perception time*. Then that person has to bring up their foot to do it. That is *reaction time*.

Average *reaction time* is about ¾ of a second. But that is only an average. It will be less with one driver and more (up to two or three seconds) with another. Age, physical condition, alertness, coordination and eyesight all will play a part in the *perception time and reaction time*. So do alcohol, drugs and frustration.

But even in ¾ of a second, a vehicle, such as a truck, moving at 60 mph (100 km/h) travels 66 feet (20 m). That is *without* a trailer behind it. That could be a lot of distance in an emergency, so keeping enough space between your vehicle and others is very important. Especially when considering that it takes ever longer to stop when you have a heavy trailer attached to your tow vehicle.

Of course, actual stopping distances vary greatly with the surface of the road (whether it is gravel or pavement); the condition of the road (wet, dry, icy); tire tread; the condition of your brakes; the weight of the vehicle and the amount of brake force applied.

The distance required to properly stop when towing a vehicle is often underestimated. As a good rule of thumb, when towing the trailer, always maintain at least 3 cars and a trailer (approximately 85 ft) length space between you and the car in front of you for every 10 miles of speed you are traveling. This should give you ample time to stop in case of an emergency.

GLOSSARY OF TIRE TERMINOLOGY

Accessory Weight – The combined weight (in excess of those standard items which may be replaced) of automatic transmission, power steering, power brakes, power windows, power seats, radio and heater, to the extent that these items are available as factory-installed equipment (whether installed or not).

Bead – The part of the tire that is made of steel wires, wrapped or reinforced by ply cords and that is shaped to fit the rim.

Bead Separation – This is the breakdown of the bond between components in the bead.

Bias Ply Tire – A pneumatic tire in which the ply cords that extend to the beads are laid at alternate angles substantially less than 90 degrees to the centerline of the tread.

Carcass – The tire structure, except tread and sidewall rubber which, when inflated, bears the load.

Chunking – The breaking away of pieces of the tread or sidewall.

Cold Inflation Pressure – The pressure in the tire before you drive.

Cord – The strands forming the plies in the tire.

Cord Separation – The parting of the cords from adjacent rubber compounds.

Cracking – Any parting within the tread, sidewall, or inner liner of the tire extending to cord material.

CT – A pneumatic tire with an inverted flange tire and rim system in which the rim is designed with rim flanges pointed radially inward and the tire is designed to fit on the underside of the rim in a manner that encloses the rim flanges inside the air cavity of the tire.

Curb Weight – The weight of a motor vehicle with standard equipment including the maximum capacity of fuel, oil, and coolant, and, if so equipped, air conditioning and additional weight optional engine.

Extra Load Tire – A tire designed to operate at higher loads and at higher inflation pressures than the corresponding standard tire.

Groove – The space between two adjacent tread ribs.

Gross Vehicle Weight Rating (GVWR) – The maximum permissible weight of this fully loaded RV.

Gross Axle Weight Rating (GAWR) – The value specified as the load carrying capacity of a single axle system, as measured at the tire-ground interfaces.

Hitch Weight – The vertical trailer load supported by the hitch ball.

Innerliner – The layer(s) forming the inside surface of a tubeless tire that contains the inflating medium within the tire.

Innerliner Separation – The parting of the inner line from cord material in the carcass.

Intended Outboard Sidewall – The sidewall that contains a whitewall, bears white lettering or bears manufacturer, brand, and/or model name molding that is higher or deeper than the same molding on the other sidewall of the tire or the outward facing sidewall of an asymmetrical tire than has a particular side that must always face outward when mounted on a vehicle.

Light Truck (LT) Tire – A tire designated by its manufacturer as primarily intended for use on lightweight trucks or multipurpose passenger vehicles.

Load Rating – The maximum load that a tire is rated to carry for a given inflation pressure.

Maximum Permissible Inflation Pressure – The maximum cold inflation pressure to which a tire may be inflated.

Maximum Loaded Vehicle Weight – The sum of curb weight, accessory weight, vehicle capacity weight, and production options weight.

Measuring Rim – The rim on which a tire is fitted for physical dimension requirements.

Non-Pneumatic Rim – A mechanical device which, when a non-pneumatic tire assembly incorporates a wheel, supports the tire, and attaches, either integrally or separably, to the wheel center member and upon which the tire is attached.

Non-Pneumatic Spare Tire Assembly – A non-pneumatic tire assembly intended for temporary use in place of one of the pneumatic tires and rims that are fitted to a passenger car in compliance with the requirements of this standard.

Non-Pneumatic Tire – A mechanical device which transmits, either directly or through a wheel or wheel center member, the vertical load and tractive forces from the roadway to the vehicle, generates the tractive forces that provide the directional control of the vehicle and does not rely on the containment of any gas or fluid for providing those functions.

Non-Pneumatic Tire Assembly – A non-pneumatic tire, alone or in combination with a wheel or wheel center member, which can be mounted on a vehicle.

Open Splice – Any parting at any junction of tread, sidewall, or innerliner that extends to cord material.

Outer Diameter – The overall diameter of an inflated new tire.

Overall Width – The linear distance between the exteriors of the sidewalls on an inflated tire, including elevations due to labeling, decorations, or protective bands or ribs.

Pin Weight – The vertical trailer load supported by the king pin of a fifth-wheel hitch.

Ply – A layer of rubber-coated parallel cords.

Ply Separation – A parting of rubber compound between adjacent plies.

Pneumatic Tire – A mechanical device made of rubber, chemicals, fabric and steel or other materials, that, when mounted on an automotive wheel, provides the traction and contains the gas or fluid that sustains the load.

Production Options Weight – The combined weight of those installed regular production options weighing over 23 kilograms (5lbs.) in excess of those standard items which they replace, not previously considered in curb weight or accessory weight, including heavy duty brakes, ride levelers, roof rack, heavy duty battery, and special trim.

Radial Ply Tire – A pneumatic tire in which the ply cords that extend to the beads are laid at substantially 90 degrees to the centerline of the tread.

Recommended Inflation Pressure – This is the inflation pressure provided by the vehicle manufacturer on the Tire Information label and on the Certification/VIN tag.

Reinforced Tire – A tire designed to operate at higher loads and at higher inflation pressures than the corresponding standard tire.

Rim – A metal support for a tire or a tire and tube assembly upon which the tire bears are seated.

Rim Diameter – This means the nominal diameter of the bead seat.

Rim Size Designation - This means the rim diameter and width.

Rim Type Designation – This means the industry of manufacturer's designation for a rim by style or code.

Rim Width – This means the nominal distance between rim flanges.

Section Width – The linear distance between the exteriors of the sidewalls of an inflated tire, excluding elevations due to labeling, decoration, or protective bands.

Sidewall – The portion of a tire between the tread and bead.

Sidewall Separation – The parting of the rubber compound from the core material in the sidewall.

Test Rim – The rim on which a tire is fitted for testing, and may be any rim listed as appropriate for use with that tire.

Tread – That portion of a tire that comes into contact with the road.

Tread Rib – A tread section running circumferentially around a tire.

Tread Separation – Pulling away of the tread from the tire carcass.

Treadwear Indicators (TWI) – The projections within the principal grooves designed to give a visual indication of the degree of wear of the tread.

Vehicle Capacity Weight – The rated cargo and luggage load plus 68 kilograms (150 lbs.) times the vehicle's designated seating capacity.

Vehicle Maximum Load On The Tire – The load on an individual tire that is determined by distributing to each axle its share of the maximum loaded vehicle weight and dividing by two.

Vehicle Normal Load On The Tire – The load on an individual tire that is determined by distributing to each axle its share of the curb weight, accessory weight, and normal occupant weight (distributed in accordance with Table I of CRF 49571.110) and dividing by 2.

Weather Side – The surface area of the rim not covered by the inflated tire.

Wheel Center Member – In the case of a non-pneumatic tire assembly incorporating a wheel, a mechanical device which attaches, either integrally or separably, to the non-pneumatic rim and provides the connection between the non-pneumatic rim and the vehicle; or, in the case of a non-pneumatic tire assembly not incorporating a wheel, a mechanical device which attaches, either integrally or separably, to the non-pneumatic tire and provides the connection between tires and the vehicle.

Wheel-Holding Fixture – The fixture used to hold the wheel and tire assembly securely during testing.

LEVELING

WARNING

FAILURE TO MAINTAIN ADEQUATE BRAKING DISTANCE BETWEEN YOUR VEHICLE AND THE VEHICLE OR ITEMS IN FRONT OF YOU CAN CAUSE PROPERTY DAMAGE, SERIOUS INJURY OR LOSS OF LIFE.

Set Up Procedures

This section outlines the procedures necessary to stabilize and set up your vehicle. Before attempting to set up the vehicle, carefully read and understand these instructions. Setting up your vehicle requires forethought and care.

Your vehicle is designed to be efficient and comfortable. Careful attention to detail and thoroughness during set up will ensure that you will benefit from all the features and comfort built into your vehicle.

During storage or after your vehicle has been set up, you may notice a slight rippling or waviness of the fiberglass exterior sidewall panels if your vehicle is sitting in the sun. This is caused by the normal expansion of the materials as they warm up. As the temperature goes down these panels will tend to return to their original shape. This condition is typical and is not covered under the HEARTLAND RECREATIONAL VEHICLES, LLC warranty.

Leveling and Stabilization

Leveling of your trailer at the site is essential. A level trailer is not only necessary for comfort but your refrigerator must be level in order to operate properly. Stabilization is recommended to keep the vehicle from bouncing while unhitched when people are moving inside the vehicle.

Stabilizer jacks are intended to stabilize the vehicle body while the vehicle's full weight is supported by the hitch jack (conventional vehicles) or landing gear (5th Wheel trailers) and running gear. Stabilizer jacks are not designed to lift or support its entire weight. **If your coach is equipped with a slide out, be sure to level main unit before extending the rooms.**

Leveling Procedures for a Conventional RV

1. If the site is not an asphalt pad, concrete slab or other prepared surface, be sure it is as level as possible. Be sure the ground surface is not soft and will support the weight of the trailer on the stabilizing jacks or other support devices.
2. Before uncoupling, level the vehicle from side to side with suitable lengths of 2" x 6" wood blocks

under the trailer wheels. Place the 2" x 6" wood blocks on the ground surface forward of the vehicle wheels, and to the trailer onto the 2" x 6" blocks. Block the trailer wheels so the trailer cannot roll.

3. Unhook the 12 volt connector and the breakaway switch cable from the tow vehicle.
4. Activate the power jack switch, or use the hand crank, to slightly raise the front of the trailer hitch to relieve the hitch pressure. Release the hitch latch disengaging the locking bar. If applicable, slightly rock the tow vehicle in reverse to disengage locking bar. Pull forward slightly and raise the recreational vehicle hitch to clear the tow vehicle hitch. Move the tow vehicle away from the recreation vehicle.
5. Level the vehicle front to rear. It may be necessary to place a sturdy 2" x 6" wood block under the jack post to support the jack post on soft ground surfaces.
6. Check the level of the vehicle with a carpenter's level both crosswise and lengthwise on the vehicle floor. To assure reasonable level at the refrigerator, use the round bubble level inside the refrigerator. Acceptable level is when the bubble is within the marked area of the bubble level.
7. After stabilizing the vehicle, be sure the vehicle frame is not twisted, buckled, or stressed. Check that all doors and windows operate freely and do not bind.
8. Connect the shore power, open the LP-Gas valves at the LP tanks and connect the fresh water supply and the water systems if necessary. If applicable, start the refrigerator, water heater and furnace.

NOTICE

DO NOT ATTEMPT TO RAISE OR OTHERWISE PLACE ALL OF THE WEIGHT OF THE TRAILER ON THE STABILIZER JACKS. STABILIZER JACKS ON THE TRAILER WITH SLIDE ROOMS SHOULD NOT BE PLACED AT EXTREME CORNERS OF THE FRAME. LOCATING STABILIZERS IN THESE LOCATIONS CAN CAUSE SLIDE ROOM DAMAGE SHOULD LEVELING BLOCKS SHIFT OR SETTLE.

CAUTION

AFTERMARKET STABILIZER STANDS MUST BE PLACED ONLY UNDER CHASSIS FRAME RAILS. IMPROPER PLACEMENT OF STABILIZER STANDS COULD CAUSE INSTABILITY AND STRUCTURAL DAMAGE TO THE UNIT.

Fifth Wheel Landing Legs Operation

The landing legs of the trailer are intended for positioning the RV during hook-up and unhooking from the tow vehicle. The landing legs also support the trailer during camping and storage. The legs are not designed for the sole support of the fifth wheel weight during tire changes or servicing.

CAUTION

THE LANDING LEG WEIGHT RATING IS 3,500 LBS. PER LEG. DO NOT EXCEED THE WEIGHT RATING.

Note

THE LEGS MAY BIND IN OVERLOAD CONDITIONS. THIS WILL RESULT IN PREMATURE WEAR OF THE DRIVE GEAR AND STRIPPING OF THE GEAR. PREMATURE GEAR WEAR WILL ALSO OCCUR WITH EXCESSIVE CLUTCHING OF THE MOTOR. THIS OCCURS AT MAXIMUM EXTENSION AND RETRACTION. ONCE CLUTCH NOISE IS HEARD, RELEASE THE SWITCH.

TO LOWER LEGS WITH ELECTRIC or HYDRAULIC MOTOR: Push the switch, located at the front of the trailer, to the extend position and hold until the landing legs raise the vehicle to the desired height. Extend and retract indicate the travel direction of the legs, not the fifth wheel.

TO RAISE LEGS WITH ELECTRIC or HYDRAULIC MOTOR: Push the switch, located at the front of the trailer, to the retract position and hold until the legs are fully retracted. Release the toggle switch as the lock pins in the landing legs near the end of the outside tubes to avoid unnecessary wear on the motor clutch.

Note

LANDING LEGS MAY WORK WITH HANDLE IF THE ELECTRIC DRIVE MOTOR IS INOPERATIVE OR IF ELECTRICITY IS UNAVAILABLE.

WARNING

REMOVE THE HANDLE BEFORE USING THE ELECTRIC MOTOR; THE HANDLE MAY JERK, CAUSING INJURY. BEFORE TOWING, CHECK FOR MAXIMUM CLEARANCE BETWEEN THE GROUND AND THE BOTTOM OF THE LANDING GEAR.

TO LOWER LEGS MANUALLY:

Insert the crank handle into the alignment tube until the end engages the crank shaft. The shaft is located at the front of the trailer. Turn the crank handle counterclockwise to raise vehicle to the desired height. Remove and store the handle.

Home is where your heart is...

TO RAISE LEGS MANUALLY:

Insert the crank handle into the alignment tube until the end engages the crank shaft. The shaft is located at the front of the trailer. Turn the crank handle clockwise to lower vehicle to the desired height. Remove and store the handle.

MAINTENANCE SCHEDULE

Before each use inspect the drop tube and the inner ram tube, replace if they are bent or damaged

Annually

- Extend landing legs as far as possible; clean the drop tube and the inner ram tube.
- Coat the exposed surface of tubes and the inside of the handle alignment tube with a silicone spray lubricant.
- Oil the shaft bushing in gear box and leg gear heads with SAE 30 oil.
- Lubricate the gears in the gear box and the landing leg gear heads with extreme pressure grease.

Every Six Months (Electric Drive Motor)

- Check the wiring connections at the battery.
- Clean the terminals with a solution of baking soda and water.
- Cover the terminals with a thin coat of grease.

Note

THE ELECTRIC DRIVE MOTOR IS LUBRICATED AT THE FACTORY AND REQUIRES NO FURTHER LUBRICATION.

Stabilizer Jacks

Stabilizing jacks, located at the rear corner on the trailer are permanently attached and operated from a standing position. These jacks are for stabilizing only. Primary leveling should be done with wheel ramps and front landing legs. Lower the stabilizing jacks until they contact the ground firmly. Place wooden blocks under the pads if necessary.

WARNING

THE STABILIZER JACK(S) MUST NOT BE USED FOR LEVELING ON UNEVEN GROUND OR TO CHANGE TIRES. NEVER USE JACK(S) TO ELEVATE ANY WHEEL OFF THE GROUND. DAMAGE TO THE STABILIZER JACK(S) AND RECREATIONAL VEHICLE FRAME CAN OCCUR.

POWER SYSTEMS

HEARTLAND RECREATIONAL VEHICLES, LLC provides one of two different power systems. Your coach has either the 30-amp or the 50-amp service detailed below.

50-Amp/110-Volt Service



If you have 50-amp service, your power cord will look like this typical 50-amp power cord, which attaches to the unit.

50-amp service is also 110-volt service, but it is capable of running up the 50-amperes of load. Some people believe that 50-amp service is the same as having 220-volts of AC power. Yes, 50-amperes of service does have 220-volts, but only 110-volts is capable of being supplied to any part of your system at any given time. A unique, four-pronged power cord identifies 50-amp service, as two of the four prongs each carry 110-volts of AC power. Each of the 110-volt lines in a 50-amp cord supplies power to a designated part of your RV. In doing this, when 110-volt AC powered components are installed they can be put on separate power feeds according to how much amperage they draw. One example of this method consists of installing two air conditioners for use at the same time. Each one is powered by a different power supply feed with the 50-amp power cord; therefore they can both be used simultaneously.

⚠ WARNING

MAKE SURE YOUR POWER SUPPLY (SHORELINE HOOKUP) IS PROPERLY GROUNDED! IF YOUR POWER SUPPLY TO THE TRAILER IS NOT GROUNDED YOU WILL EXPERIENCE A DANGEROUS SHOCK WHEN STANDING ON THE GROUND AND TOUCHING A METAL PORTION OF YOUR TRAILER! USE A CONTINUITY TESTER TO ENSURE PROPER POWER SUPPLY!

⚠ CAUTION

DO NOT USE AN EXTENSION CORD WITH A CURRENT RATING LESS THAN THE AMPERAGE YOUR RV REQUIRES. EXTRA EXTENSION CORDS REDUCE THE AMPERAGE AND VOLTAGE BEING SUPPLIED TO THE RV AND MAY CAUSE DAMAGE TO ELECTRICAL COMPONENTS, INCLUDING THE SHORELINE CORD.

Note

IF YOU TRAVEL TO AN RV PARK THAT DOES NOT OFFER THE APPROPRIATE AMP SERVICE YOUR COACH REQUIRES, YOU WILL HAVE TO USE AN ADAPTER TO HOOK UP TO SHORE POWER. USE OF AN ADAPTER IS NOT RECOMMENDED, BUT MAY NOT BE AVOIDABLE. WHEN USING AN ADAPTER, REMEMBER THAT YOUR COACH WILL NOT HAVE SUFFICIENT POWER TO RUN AS MANY OPTIONS AS WITH FULL-AMP SERVICE. YOU MAY BE ABLE TO RUN BOTH YOUR AIR CONDITIONERS FOR A LIMITED TIME; HOWEVER, THIS WILL CAUSE DAMAGE TO BOTH YOUR AC UNITS AS WELL AS OTHER COMPONENTS BY OPERATING THEM WITH INSUFFICIENT POWER.

AMP Usage

Listed below are components that might be used in HEARTLAND RECREATIONAL VEHICLES, LLC vehicles and the typical maximum amperage draw each one has. This chart may help you decide which components you can safely use for an extended period without damage.

<u>Components</u>	<u>Amperage</u>
Roof air conditioners (each)	15
Electric water heater	12
Microwaves	12
Hair dryer	8
TV	4
DVD	5
Charger	14
Refrigerator	3.5
110-volt lamp	1.0

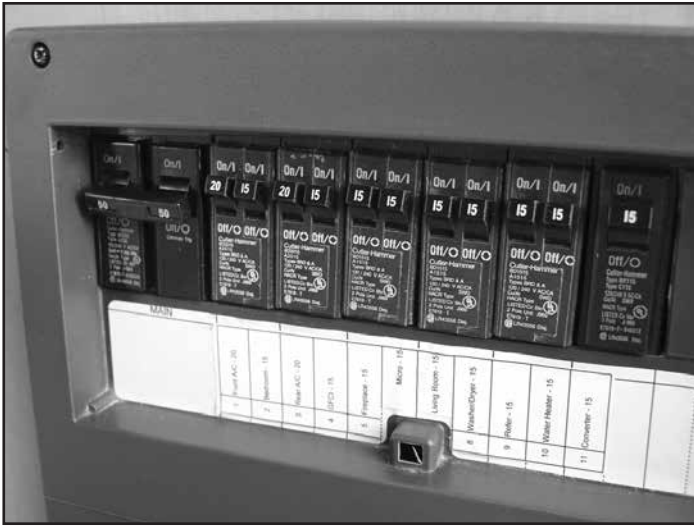

Power Convertor

Your vehicle is equipped with an electrical power convertor that changes 110-volt power to 12-volt power to run 12-volt powered appliances in your vehicle. It gets the 110-volt power by way of the shoreline (shown previously). Shown here is the circuit breaker/fuse box for the 110V electrical system.

Circuit Breakers

Circuit breakers and fuses protect the circuits in the vehicle. Locate the converter and see where the fuses are located. If you blow a fuse, turn off the appliance. Unplug the fuse. Check the fuse for breakage and replace it with a new fuse of the proper rating. If the fuse continues to fail, contact your nearest dealer. **NEVER REPLACE A FUSE WITH A HIGHER RATED FUSE THAN WHAT IS DESIGNATED.**

⚠ WARNING

NEVER REPLACE CIRCUIT BREAKERS OR FUSES OF HIGHER CURRENT RATING THAN THOSE ORIGINALLY INSTALLED. THIS COULD OVERHEAT THE WIRING AND START A FIRE, POSSIBLY RESULTING IN PROPERTY DAMAGE, PERSONAL INJURY OR LOSS OF LIFE.

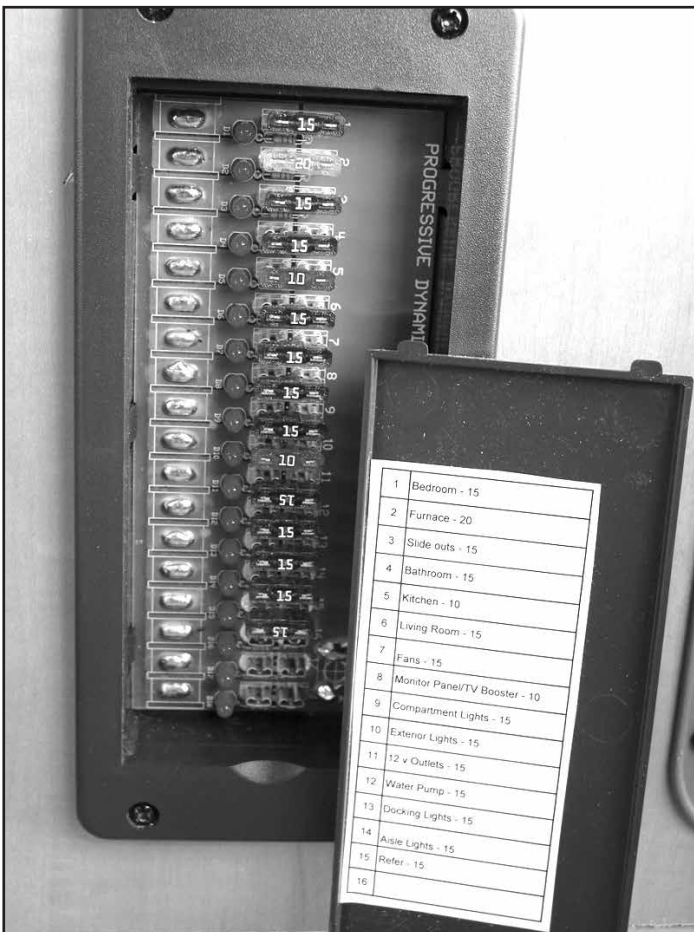

ELECTRICAL SYSTEM

Your electrical system is a combination of 12-volt and 110-volt systems, every facet carefully engineered and installed to comply with the “National Electric Code”.

The combination system consists of:

1. 12-volt automotive system – DC.
2. 110-volt outside power source – AC.

110-Volt System

This is supplied by plugging the power cord into an outside 110-volt receptacle. It furnishes current to 110-volt roof air conditioners, refrigerator and all internal 110-volt receptacles. It also supplies power for the 12-volt trailer system through the converter.

The 110-volt circuits are protected by resettable circuit breakers, similar to the ones you would find in your home. Depending on your recreational vehicle the number of 110 volt appliances available, the circuit panel may have a 50 amp main or a 30 amp main breaker. All breakers are labeled for what appliance they protect and maximum amperage for the circuit breaker.

Your bathroom, kitchen and exterior receptacles are protected by a highly sensitive device known as a “Ground Fault Interrupter”, which is designed to sense the slightest electrical “short” at those receptacles and instantly disconnect the current before a person can be injured.

This device protects against fault currents only. It does NOT protect against over current.



The GFI receptacle is located in the bathroom; it should be tested at least once a month for maximum protection. To test the GFI receptacle push the TEST button. The RESET button will pop out. Power is now off at the outlets protected by the RESET button during the test and indicates the device is functioning properly. If the RESET button does not pop out when testing, do not use any outlets on this circuit. Protection is lost. Call your dealer if this device malfunctions. After a successful test, restore power by pushing RESET. Your test is complete when the RESET button stays pushed in.

**THIS CONNECTION IS FOR
LOW-VOLTAGE BATTERY
OR DIRECT CURRENT ONLY.
DO NOT CONNECT TO 120
OR 240 VOLTS AC.**

Battery

Your trailer, in most cases, needs to be equipped with a 12 volt battery. Check the electrolyte fluid levels on a regular basis, especially during hot weather conditions. Refill as necessary with either distilled water or clean tap water in an emergency. **DO NOT ALLOW THE FLUID LEVELS IN THE BATTERIES TO FALL BELOW THE INTERNAL BATTERY PLATES. DAMAGE TO THE BATTERIES MAY RESULT AND SHORTEN THE LIFE OF THE BATTERIES.**

WARNING

DO NOT ALLOW THE BATTERY FLUID TO CONTACT YOUR SKIN, EYES, FABRIC OR PAINTED SURFACES. THE FLUID COULD CAUSE SERIOUS PERSONAL INJURY OR PROPERTY DAMAGE. WEAR EYE PROTECTION WHEN WORKING WITH ANY BATTERY.

When charging the battery(s), do not charge at such a fast rate as to cause spewing of the electrolyte from the cells. If your battery has problems prior to the end of their warranty period, consult the nearest representative of the battery manufacturer.

When it is time to replace the batteries, be sure to replace them with quality batteries of equal electrical and physical properties. Contact your nearest dealer for advice in the selection of new batteries.

CAUTION

DO NOT ALLOW CORROSION TO DEVELOP ON THE BATTERY TERMINALS. CORRODED TERMINALS CAN CAUSE A LOSS OF AVAILABLE POWER, CUT DOWN ON THE EFFICIENCY OF THE CHARGING/ELECTRICAL SYSTEM, OR POSSIBLE BATTERY FAILURE.

⚠ WARNING

DO NOT SMOKE OR USE AN OPEN FLAME AROUND BATTERIES. AVOID MAKING ELECTRICAL SPARKS NEAR BATTERIES. FUMES FROM THE BATTERIES ARE COMBUSTIBLE.

The batteries should be removed and stored in a warm place when not used in your vehicle for an extended period of time (i.e. more than 60 days). Mark the cables, positive and negative, for easy identification. Batteries are not to be stored on concrete floors. The batteries require periodic charging during storage. If the vehicle is to be stored for a long period of time, it is recommended that all of the batteries inside the unit be removed from clocks, radios, smoke alarms, etc. This will prevent unnecessary drain and corrosion of the batteries.

Battery Types and Charging

Only similar batteries should be connected together in one bank if you choose to have more than one battery. Do not connect old and new batteries, or wet and gel cell batteries together. Deep-cycle batteries are usually rated in Amp-hours, which is based on a 20-hour discharge rate. Therefore, a 100 amp-hour battery can deliver 5 amps for 20 hours. Deep-cycle batteries can be discharged about 80% of capacity before damage occurs. Shallow cycling (50-60% drain before recharge) will result in much longer battery life.

To find out how long your batteries will last when using various equipment in your coach, research the amperage of the items in use, and use that number to gauge what size amp-hour battery you think you need. Keep in mind that you should recharge your batteries when they are 50% discharged, so only half the amp-hour rating is actually used.

Your battery will be charged slowly when the trailer is hooked up to the tow vehicle by the tow vehicle's electrical system. The converter will also charge your battery when the trailer is plugged into shore power.

Battery Disconnect Panel

On some models, this is done to prevent the coach batteries from being drained during storage. It disconnects all the 12 volt circuitry from the batteries. When taking the unit out of storage, turn to re-connect the batteries. This will make the 12-volt system ready for use.



Monitor Panel

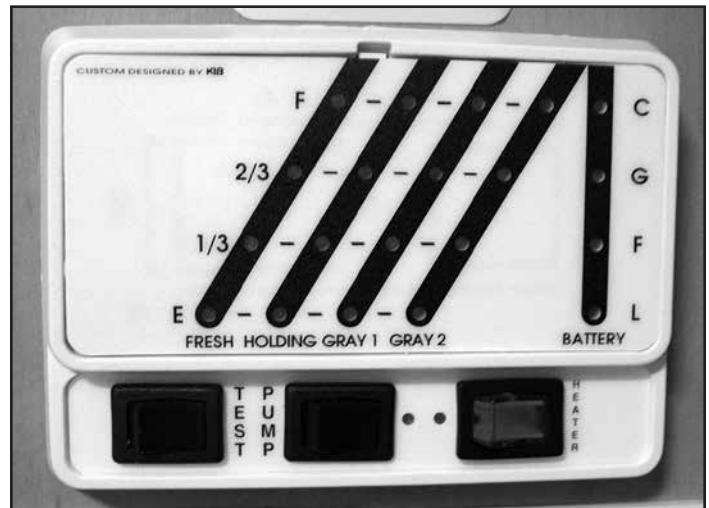

Your vehicle has a monitor panel that can provide you with important information about various systems on the RV. This panel also houses the water pump switch.

This monitor panel will give you information including:

- How much potable (fresh) water remains.
- How full your black (sewage) tank is.
- How full your gray (waste water) tank is.

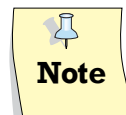

Note

THE MONITOR PANEL WILL GIVE FALSE READINGS IF THE SENSORS IN THE HOLDING TANKS ARE COVERED WITH DEBRIS. CLEAN YOUR WASTE HOLDING TANKS FREQUENTLY WITH APPROVED TREATMENTS.

GENERATORS

IMPORTANT: MAKE SURE TO READ AND UNDERSTAND THE GENERATOR OWNER'S MANUAL BEFORE OPERATING THE GENERATOR.

Some RVs are equipped with onboard generators, or designed with generator compartments designed for specific types of generators that make your RV fully self-contained. There are also portable generators that are designed to be used with RVs. Keep in mind that generator exhaust contains carbon monoxide and is deadly! Observe all operating instructions and warnings as well as all recommended maintenance schedules and procedures outlined in the generator owner's manual. NEVER sleep in the RV with the generator running!

Test the carbon monoxide detector every time you use the RV.

Before you start and use the generator inspect the exhaust system. Do not use it if the exhaust system is damaged.

Know what the symptoms of carbon monoxide poisoning are:

- Dizziness
- Weakness
- Nausea
- Intense headache
- Inability to think coherently
- Muscular twitching
- Sleepiness
- Vomiting
- Throbbing in the temples

If you or anyone else experience any of these symptoms get to fresh air immediately. Shut the generator down and do not operate it until it has been inspected and repaired by a professional. If the symptoms persist seek medical attention immediately.

1. DO NOT operate the generator while sleeping. You would not be aware of exhaust entering the RV, or alert to symptoms of carbon monoxide poisoning.
2. NEVER store anything in the generator compartment. Always keep compartment clean and dry.
3. NEVER use a portable generator in the generator compartment. The generator compartment is designed for onboard generators and exhausted accordingly.
4. DO NOT operate the generator in an enclosed building or in a partly enclosed area such as a garage, or underneath any portion of the RV, including slide-outs.
5. Review the safety precautions for fuel and exhaust fumes elsewhere in this manual.

6. DO NOT operate the generator when the RV is positioned in high grass or brush. Heat from the exhaust could cause a fire in dry conditions.
7. DO NOT simultaneously operate generator and a ventilator which could result in the entry of exhaust gas. When exhaust ventilators are used, we recommend that a window on the opposite side of the RV "upwind" of exhaust gases be opened to provide cross ventilation.
8. When parked, orient the RV so that the wind will carry the exhaust away from the RV. DO NOT open nearby windows, ventilators, or doors into the passenger compartment, particularly those which can be "down wind", even part of the time.
9. If using a portable generator, make sure the generator is OUTSIDE in a well-ventilated area and as FAR AWAY from the RV as possible. Position the portable generator so the wind will carry the exhaust away from the RV. DO NOT open nearby windows, doors, or vents.
10. DO NOT operate the generator when parked in close proximity to vegetation, snow, buildings, vehicles, or any other object that could deflect the exhaust under or into the vehicle.
11. DO NOT touch the generator when running, or immediately after shutting off. Heat from the generator can cause burns. Allow the generator to cool before attempting maintenance or service.

DANGER

DANGER CARBON MONOXIDE: Generator exhaust contains carbon monoxide. This is a colorless, odorless, poison you cannot see or smell and can cause unconsciousness and death. If you start to feel dizzy or weak, get to fresh air immediately.

- NEVER use a portable generator inside the RV, inside the garage, inside the generator compartment of the RV, or under the RV or slide-out rooms. Using a generator indoors can KILL YOU IN MINUTES.
- Only use OUTSIDE and far away from the RV and windows, doors, slide-outs, vents, or any other opening.
- DO NOT allow exhaust fumes to enter a confined area through windows, doors, vents, or other openings.
- Read your generator manufacturer's owner's manual, and your HRV owner's manual prior to operating a generator and follow all instructions regarding the operation and use of the generator.

FIRE SAFETY

The possibility of fire exists in all areas of life, and the recreation vehicle life-style is no exception. Recreational vehicles are complex machines. They are made up of many materials, some of which are flammable. Like many hazards, the possibility of fire can be minimized. This is done by recognizing the danger and practicing common sense safety and maintenance habits. For safety reasons, your unit is furnished with both a fire extinguisher and a smoke alarm.

Fire Extinguisher

The fire extinguisher is rated for Class B (grease, gasoline, diesel fuel, flammable liquids) and Class C (electrical) fires. These are the most common types of fires in vehicles. Read the operator's manual and the instructions on the fire extinguisher. Be sure to know how and when to use the extinguisher and where it is located.

Fire extinguishers are mechanical, pressurized devices. Care must be exercised when they are handled. They must be maintained as the operator's manual instructs for proper and safe operation. The extinguisher should be inspected at least once a month. More frequent inspections may be required if the extinguisher is exposed to the weather or the possible tampering. Do not test the extinguisher by partially discharging; doing this will cause a loss of pressure.

If a fire occurs in the vehicle, evacuate the vehicle as quickly and as safely as possible. Consider the cause and the severity of the fire and the risk involved before trying to extinguish it. If the fire is major or fuel fed, move away from and stand clear of the vehicle and wait for emergency assistance to arrive.

⚠ WARNING

TEST SMOKE DETECTOR OPERATION AFTER VEHICLE HAS BEEN IN STORAGE, BEFORE EACH TRIP, AND AT LEAST ONCE PER WEEK DURING USE. FAILURE TO COMPLY COULD RESULT IN FIRE OR SERIOUS INJURY.

Smoke Detector

The battery-powered smoke detector is mounted on the ceiling in the living area of the unit. Read the operating instructions for details on the testing and care for this important safety device. Test the smoke detector after the unit has been in storage, before each trip, and at least once a week during use. The detector should never be disabled because of nuisance or false alarm from cooking smoke or a dusty furnace. Ventilate the unit with fresh air and the alarm will shut off. Never disconnect or remove the battery from the smoke alarm.

The battery should be replaced no less than once a year or when the low battery signal sounds.

⚠ WARNING

TEST SMOKE ALARM OPERATION AFTER VEHICLE HAS BEEN IN STORAGE, BEFORE EACH TRIP, AND AT LEAST ONCE PER WEEK DURING USE. FAILURE TO COMPLY MAY RESULT IN SERIOUS INJURY.



Emergency Exit Window

Throughout the unit, there are Emergency Exit (egress) windows. These windows are designed to be used as an additional exit in emergency situations. It can be identified easily by the red handle and red "EXIT" label. To open the egress window, familiarize yourself and occupants with proper procedure.

There should be two paths of escape from each sleeping area. Familiarize yourself and occupants with these paths and the location of the exits.

Furnace

The furnace utilizes a sealed combustion system, which means the combustion chamber is completely sealed from the inner atmosphere of your vehicle. Combustion air is drawn from the outside and combustion products are expelled outside through a vent.

Carefully read and follow the lighting and operating instructions from the furnace manual supplied with the unit.

New furnaces sometimes emit smoke and an odor when first used due to paint burning off the heating chamber. Do not mistake this for a malfunctioning furnace. You may want to open the windows during the initial breaking in of the furnace.

Thermostat readings may not always be a true indication of temperature throughout the living space. Use these readings as a guide to obtain the most comfortable level for you.

⚠ WARNING

DO NOT STORE COMBUSTIBLE MATERIAL IN THIS AREA. FAILURE TO COMPLY COULD RESULT IN A FIRE OR PERSONAL INJURY.

LP GAS SYSTEM

WARNING

IF YOU SMELL GAS:

1. EXTINGUISH ANY OPEN FLAMES, PILOT LIGHTS AND ALL SMOKING MATERIALS.
2. DO NOT TOUCH ELECTRICAL SWITCHES.
3. SHUT OFF THE GAS SUPPLY AT THE TANK VALVE(S) OR GAS SUPPLY CONNECTION.
4. OPEN DOORS AND OTHER VENTILATION OPENINGS.
5. LEAVE THE AREA UNTIL ODOR CLEARS.
6. HAVE THE GAS SYSTEM CHECKED AND LEAKAGE SOURCE CORRECTED BEFORE USING AGAIN.

WARNING

A warning label has been located near the LP gas container. This label reads:
DO NOT FILL CONTAINER(S) TO MORE THAN 80 PERCENT OF CAPACITY. Overfilling the LP gas container can result in uncontrolled gas flow, which can cause fire or explosion. A properly filled container will contain approximately 80 percent of its volume as liquid LP gas. Safety regulation prevents filling over 80 percent.

WARNING

Portable fuel-burning equipment, including wood and charcoal grills and stoves, must not be used inside the recreational vehicle. The use of this equipment inside the recreational vehicle may cause fires or asphyxiation.

WARNING

Storage of LP gas containers, gasoline or other flammable liquids inside your vehicle – even for short periods of time – presents a risk of fire and/or explosion. All flammable liquids should be stored safely in a well-ventilated area outside your vehicle and in proper containers.

WARNING

LP gas regulators must always be installed with the diaphragm vent facing downward. Regulators that are not in compartments have been equipped with a protective cover. Make sure that the regulator vent faces downward and that the cover is kept in place to minimize vent blockage which could result in excessive gas pressure causing a fire or explosion.

WARNING

ALL PILOT LIGHTS, APPLIANCES AND THEIR IGNITERS (SEE OPERATING INSTRUCTIONS) SHALL BE TURNED OFF DURING REFUELING OF MOTOR FUEL TANKS AND/OR PROPANE CONTAINERS. FAILURE TO COMPLY CAN RESULT IN DEATH OR SERIOUS INJURY.

Liquid Propane (LP) gas, when properly handled, is a clean burning, dependable fuel for all your LP gas appliances. The LP tank or tanks mounted on your unit contain liquid under high pressure. The liquid vaporizes into a gas and passes through the regulator which automatically reduces the gas pressure. The low pressure gas is then distributed to the appliances. The arrow on the automatic gas regulator will always point to the gas tank in service. When the red flag appears in the inspection glass this indicates that the tank is empty. The arrow should be turned to allow the full tank to pressurize the system and the empty tank should be filled as soon as possible.

Each tank has an automatic eighty percent stop-fill valve that allows space in the tank for vapor expansion. The high pressure vapor in the tank is reduced in two stages as it makes its way to your appliance. The tank pressure will vary with temperature and altitude, but it may be in the range of 100 to 250 pounds per square inch (psi) or more. It is reduced by a pressure regulator to about 12 psi in the first stage and then to about 6.35 ounces in the second stage. The 6.35 ounces can also be expressed as 11 inches of water column.

The LP gas system is designed and built to rigid standards and tested before leaving the factory. Your dealer also tests the system prior to customer delivery.

NOTE

YOUR DEALER IS RESPONSIBLE FOR A THOROUGH LP GAS SYSTEM CHECK PRIOR TO DELIVERY. DO NOT ACCEPT THE UNIT UNTIL THIS CHECK HAS BEEN COMPLETED.

Except for simple maintenance and occasionally tightening a connection, you should take your unit to an authorized dealer for LP gas problems. An authorized LP supplier should always fill the LP gas tank.

WARNING

LP-GAS CYLINDERS SHALL NOT BE PLACED OR STORED INSIDE THE VEHICLE. LP-GAS CYLINDERS ARE EQUIPPED WITH SAFETY DEVICES THAT RELIEVE EXCESSIVE PRESSURE BY DISCHARGING GAS TO THE ATMOSPHERE. FAILURE TO COMPLY COULD RESULT IN DEATH OR SERIOUS INJURY.



Note

YOUR UNIT'S MANUFACTURER IS NOT RESPONSIBLE FOR PERSONAL INJURY OR PROPERTY DAMAGE RESULTING FROM IMPROPERLY MAINTAINED LP GAS APPLIANCES AND SYSTEMS.

CAUTION

THIS GAS PIPING SYSTEM IS DESIGNED FOR USE WITH LP-GAS ONLY. DO NOT CONNECT NATURAL GAS TO THIS SYSTEM. SECURELY CAP THIS INLET WHEN NOT CONNECTED FOR USE. AFTER TURNING ON GAS, EXCEPT AFTER NORMAL CYLINDER REPLACEMENT, TEST GAS PIPING AND CONNECTIONS TO APPLIANCE FOR LEAKAGE WITH SOAPY WATER OR BUBBLE SOLUTION. DO NOT USE PRODUCTS THAT CONTAIN AMMONIA OR CHLORINE.

WARNING

NEVER ADJUST THE REGULATOR YOURSELF. HAVE YOUR DEALER OR AN AUTHORIZED SERVICE TECHNICIAN MAKE ANY REQUIRED ADJUSTMENTS.

Filling LP Gas Bottles

When your LP gas tank is empty, have it refilled as soon as possible. There are many LP refueling stations available. Many RV parks also have LP gas available. Caution your supplier not to over fill your tank. Room is required to let the liquid vaporize.

There are approximately 90,000 BTUs of heat produced from each gallon of LP gas. During extreme cold temperatures, check fuel tanks frequently to avoid running out of fuel.

Make sure that all burners and pilot lights are turned OFF prior to having a gas supplier refill your LP tank.

1. Make sure the arrow on the cylinder selector is pointed to the full cylinder. (Verify the hose route to the full cylinder on a split system.)
2. Close the valve on the empty cylinder and remove the hose from the valve. (NOTE: left hand thread).
3. Loosen the clamp that holds the cylinder in place.
4. Remove the cylinder and have it refilled.

5. Slide the cylinder back in place and tighten clamp.
6. Connect the left-hand hose and tighten securely

The 80 percent STOP FILL VALVE may close the valve before liquid appears at the 20 percent liquid level gauge, but if liquid does appear, stop filling immediately...the tank is filled to its LP capacity.



Note

YOUR LP TANKS MUST BE KEPT FREE OF RUST AT ALL TIMES. IF RUST DOES DEVELOP, THE TANK SHOULD BE CLEANED COMPLETELY FREE OF THE RUST, PRIMED, AND PAINTED WHITE (OR SOME OTHER HIGHLY REFLECTIVE COLOR) WHICH WILL HELP TO REDUCE EXPANSION OF THE LP GAS BECAUSE OF HEAT.

Do not use a wrench to tighten the service valve or the 20 percent gauge. They are both designed to be closed leak-tight by hand. If you cannot hand-tighten the valve, the valve may need repair or replacement. Consult your gas dealer.

DANGER

IF YOU SMELL PROPANE

1. Extinguish any open flames, pilot lights and all smoking materials.
2. Do not touch electrical switches.
3. Shut off the propane supply at the container valve(s) or propane supply connection.
4. Open doors and other ventilating openings.
5. Leave the area until odor clears.
6. Have the propane system checked and leakage source corrected before using again.

FAILURE TO COMPLY COULD RESULT IN EXPLOSION RESULTING IN DEATH OR SERIOUS INJURY.

LP Gas Lines

The primary manifold is a black pipe located under the unit. Copper tubing with flare fittings are used as secondary lines running to the gas appliances. **Should any lines ever rupture, NEVER attempt to splice them.** A new line should always be installed. We recommend any LP gas line services be performed by your dealer or an authorized service technician. Always close main valve at LP tank when servicing any gas appliance. This prevents any gas leakage which could result in an explosion or cause serious bodily injury.

WARNING

NEVER CHECK GAS LINES FOR LEAKS WITH AN OPEN FLAME. DO NOT CHECK FOR LEAKS USING AMMONIATED OR CHLORINATED HOUSEHOLD TYPE DETERGENTS. THESE DETERGENTS CAN CAUSE CRACKS TO FORM ON THE METAL TUBING AND BRASS FITTINGS. TAKE THE UNIT TO A QUALIFIED LP GAS SERVICE TECHNICIAN TO FIND AND REPAIR THE LEAK. KEEP THE TANK VALVE CLOSED AND ALL OF THE APPLIANCES TURNED OFF WHEN THE UNIT IS STORED. IF ANY OF THE LP GAS VALVES DO NOT CLOSE LEAK-TIGHT BY HAND, CONSULT A SERVICE TECHNICIAN.

Although your LP gas system was thoroughly inspected for leaks before delivery, gas fittings can loosen from vibration during travel. Your LP gas system should be inspected at least every three months and before every trip. If a leak is suspected, check immediately!

Precautions and Recommendations

- Inspect LP fill valve for foreign material before refueling.
- Shut off tow vehicle and pilot lights when refueling gas tanks.
- Never check for gas leaks with an open flame match, etc.
- Visually inspect gas lines for any problem periodically.
- Have dealer inspect gas systems yearly and before and after long trips. Always have a qualified technician check and make any repairs in your gas system.

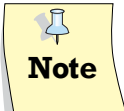

Note

THIS GAS PIPING SYSTEM IS DESIGNED FOR USE OF LIQUEFIED PETROLEUM GAS ONLY. DO NOT CONNECT NATURAL GAS TO THIS SYSTEM. DO NOT FILL CONTAINER(S) TO MORE THAN 80 PERCENT OF CAPACITY. SECURELY CAP INLET(S) WHEN NOT CONNECTED FOR USE. AFTER TURNING ON GAS, EXCEPT AFTER NORMAL CONTAINER REPLACEMENT, TEST GAS PIPING AND CONNECTIONS TO APPLIANCES FOR LEAKAGE WITH SOAPY WATER OR BUBBLE SOLUTION. DO NOT USE PRODUCTS THAT CONTAIN AMMONIA OR CHLORINE.

WARNING

ALL PILOT LIGHTS, APPLIANCES AND THEIR IGNITERS (SEE OPERATION INSTRUCTIONS) MUST BE TURNED OFF DURING REFUELING OF MOTOR FUEL TANKS AND/OR LP GAS CONTAINERS.

WARNING

**THIS SYSTEM IS DESIGNED FOR USE WITH PROPANE ONLY:
DO NOT CONNECT NATURAL GAS TO THIS SYSTEM.**

BEFORE TURNING ON PROPANE:

- BE CERTAIN APPLIANCES ARE CERTIFIED FOR PROPANE AND ARE EQUIPPED WITH CORRECT BURNER ORIFICES.**
- MAKE CERTAIN ALL PROPANE CONNECTIONS ARE TIGHT BY TESTING WITH SOAPY WATER, ALL APPLIANCE VALVES ARE TURNED OFF, AND ANY UNCONNECTED OUTLETS ARE CAPPED.**

AFTER TURNING ON PROPANE:

- LIGHT ALL PILOTS.**
- ALL CONNECTIONS, INCLUDING THOSE AT THE APPLIANCES, REGULATORS, AND CYLINDERS, SHOULD BE LEAK-TESTED PERIODICALLY WITH SOAPY WATER BY THE OCCUPANT. NEVER USE A LIGHTED MATCH OR OTHER FLAME WHEN CHECKING FOR LEAKS.**
- DO NOT LEAVE SYSTEM TURNED ON OR CONTAINERS CONNECTED UNTIL THE SYSTEM HAS BEEN PROVEN TO BE FREE OF ANY LEAKS.**
- COOKING APPLIANCES SHOULD NOT BE USED FOR SPACE HEATING.**
- WHEN THE CONTAINERS ARE DISCONNECTED, THE PROPANE SUPPLY LINE SHOULD BE CAPPED OR PLUGGED.**

Climate Differences

The appliances in your vehicle will not function if the LP gas does not vaporize. Propane will continue to vaporize down to -44 degrees F.

Propane has become the main type of LP gas used in RVs in recent years. Butane should not be used. The LP gas dealer will have the correct type or blend for his locale. If you plan on traveling from a warm climate to a cold climate, check with your local gas dealer to see if the blend he supplies is appropriate for the part of the country you plan on visiting.

Operation

To operate any LP gas appliance, the LP gas tank's service valve must be OPEN. When first used, or after a refill, there may be some air in the gas lines that will escape when the range burner or similar gas valve is opened. The air may extinguish the match or igniter the first time or two you attempt to light a stove burner. Also remember that when you close the tank's service valve, some gas will remain in the lines. To completely bleed the lines of gas, close the tank valve and light the range burner. When the flame burns out, turn off the appliance.

Overview of Typical LP Gas Hook Up

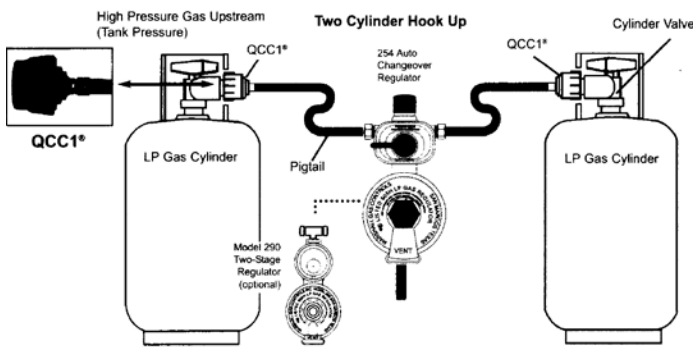

Regulator Pressure

Have the gas regulator checked at beginning of each season and whenever a problem occurs. Proper line pressure is 11 inches of water column. Your RV dealer or gas supplier can perform this needed check.

Gas Line Check

Check the gas line connectors and all other connections regularly. To check, turn OFF all burners and pilot lights. Open all doors and windows. OPEN the LP gas tank's service valve and use soapy water or an approved leak detector fluid to test all line connections. Do not use products that contain AMMONIA or CHLORINE. The

appearance of bubbles in the soapy solution indicates a leak. Tighten the connections with two (2) open-end wrenches until the bubbles stop. If this does not take care of the leak, contact your gas dealer. DO NOT OVERTIGHTEN.

Gas Tank and Regulator Freeze-Up

LP gas regulator freeze-up can be prevented if owners are aware of the causes. Freeze-up may be caused by one of the following: moisture in the tank, an overfilled tank or a greater vapor withdrawal demand than the tank can deliver at a particular temperature.

Freeze-up occurs more frequently in cold weather since liquid gas does not vaporize as quickly. This, along with a higher demand, can cause frost on the tank and regulator.

Be sure to have your LP gas supplier add ANHYDROUS METHANOL before filling the tank in cold weather.

Moisture may enter the tank in the LP gas through condensation if air is allowed to enter the tank through an open valve. This can be avoided by using moisture-free gas and keeping all tank valves CLOSED during

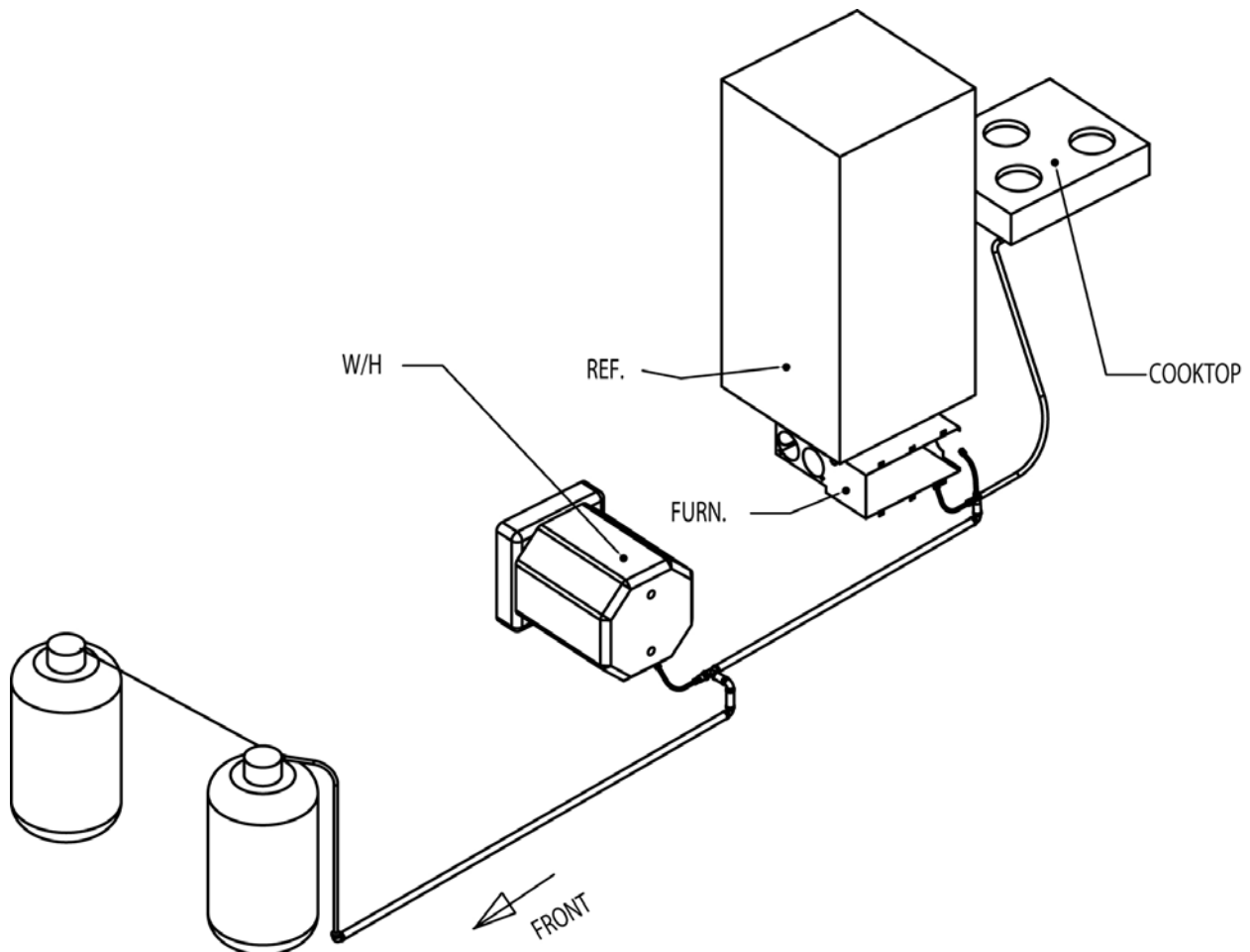

storage. If moisture is present, have the tank purged by an authorized dealer and have him add the proper amount of ANHYDROUS METHANOL for your tank. An overfilled tank can allow liquid gas, rather than the needed vapor, to flow through the regulator. This can result in erratic regulator delivery pressure, improper appliance operation and possible frosting of the regulator and gas line. This can be avoided by following the procedures outlined in the Filling LP Gas Bottles section. Always contact your local gas supplier for current procedures.

Hose Replacement

The flexible LP gas hoses connected to your LP tank should be checked frequently for signs of deterioration and may need to be replaced every two to three years. Be sure to replace the hoses with approved and properly rated products.

Regulator Vent Maintenance

Since the LP gas regulator is equipped with a vent that allows the system to “breathe”, you must check it on a frequent basis to see that it does not become clogged. If dirt, sealant or corrosion clogs the vent, clean it with a toothbrush or similar device. At least once a year have your LP service provider check the regulator adjustment and operation.

LP Gas Detector

Liquid Propane (LP) gas is heavier than air and will settle to the lowest point of the room, which is generally on the floor of your coach. Because of this, the LP detector installed in your coach is located near the floor. The detector is also sensitive to other fumes, such as hair spray, which contain butane as the propellant. Butane, like propane, is heavier than air and will settle to the floor level where it may be detected.

The detector is equipped with a “sensor activation strip”. This strip must be removed for the detector to operate properly. This should have been done during the dealer’s pre-delivery inspection. Please check the detector to verify that the activation strip has been removed.

Please consult your LP detector User’s Guide for more detailed information

WARNING

A WARNING LABEL LOCATED IN THE COOKING AREA REMINDS YOU TO PROVIDE AN ADEQUATE SUPPLY OF FRESH AIR FOR COMBUSTION. UNLIKE HOMES, THE AMOUNT OF OXYGEN SUPPLIED IS LIMITED DUE TO THE SIZE OF THE RECREATIONAL VEHICLE; PROPER VENTILATION WHEN USING THE COOKING APPLIANCE(S) WILL AVOID DANGER OF ASPHYXIATION. IT IS ESPECIALLY IMPORTANT TO ENSURE A FLOW OF FRESH AIR WHEN THE APPLIANCE IS USED FOR LONG PERIODS OF TIME.

WARNING

THIS IS NOT SAFE TO USE COOKING APPLIANCES FOR COMFORT HEATING.

Cooking appliances need fresh air for safe operation.

Before operation:

- 1. Open overhead vent or turn on exhaust fan.**
- 2. Open window.**

FAILURE TO COMPLY COULD RESULT IN DEATH OR SERIOUS INJURY.

PLUMBING

Fresh Water

Fresh water is provided by filling the FRESH WATER TANK or by hooking directly to a city water connection. These sources supply water for the kitchen sink, shower, lavatory, toilet and water heater. Fill the FRESH WATER TANK using the connection shown on the left side of the photo below



City Water and Gravity Fill Connections

Located on the exterior of the coach is the CITY WATER INLET. Connect a hose to a city pressurized faucet to the connection on the right of the photo above.

Fresh Water Tank

UNLOCK the GRAVITY WATER FILL DOOR and use a hose or vessel to fill the water tank. Watch your monitor panel inside to determine when the tank is full.

NOTICE

NEVER LEAVE YOUR COACH UNATTENDED WHILE FILLING THE FRESH WATER TANK! ALTHOUGH PROPER VENTING IS ALLOWED FOR OVERFLOW, THE WATER PRESURE CAN EXPAND THE TANK AND CAUSE SEVERE DAMAGE TO YOUR UNIT.

NOTICE

A PRESSURE REGULATOR SHOULD ALWAYS BE USED WHEN CONNECTING TO CITY WATER. EXCESSIVE WATER PRESSURE CAN DAMAGE LINES AND CONNECTIONS, CAUSING WATER DAMAGE TO YOUR RV. MAKE SURE WATER PRESSURE NEVER EXCEEDS 60 PSI.

Holding Tank Flush System

A holding tank flush kit may be installed on your unit. To use this system, connect a water hose to the flush kit connector. After connecting your water hose, turn on the water to begin to flush your tank. For best results, leave the dump valve closed until you have flushed the tank. Do not leave the flush system unattended, unless you decide to leave your dump valves open. See the flush kit's manufacturer's operating instruction for full details and instruction.

Sanitizing System

⚠ WARNING

POTABLE WATER ONLY. SANITIZE, FLUSH AND DRAIN BEFORE USING. SEE INSTRUCTION MANUAL. FAILURE TO COMPLY COULD RESULT IN DEATH OR SERIOUS INJURY

To assure complete sanitation of your potable water system, the following procedures are recommended for a new system. For one that has not been used for a period of time and for one which may have become contaminated:

1. Prepare a chlorine solution using one (1) gallon of water and one-quarter (1/4) cup of household bleach (5% sodium hypochlorite solution). With tank empty, pour one (1) gallon of solution into the tank for each fifteen (15) gallons of tank capacity. **NOTE:** As an option, several commercial solutions are available and should be used as directed on the package.
2. Complete filling of tank with fresh water. Operate all faucets to release trapped air. Pressuring entire system with pump, if available, and turn off pump.
3. Allow to stand for three (3) hours.
4. Drain and flush with fresh potable water.
5. To remove excessive chlorine taste or odor which may remain, prepare a solution of one (1) quart vinegar to five (5) gallons water and pour into tank. Allow solution to agitate in tank by vehicle motion (several days, if possible).
6. Drain tank and flush with fresh potable water.

Fresh Water Lines

Vibration and flexing during traveling can cause pipes and fittings to work loose. Check all of the plumbing connections for leaks on a regular basis and not less than annually. If the water pump runs when all faucets are turned off, check for a leak. Be sure the drain valves are closed. Connections and the kitchen and bathroom faucets normally seal with hand tightening and a half turn with a wrench. If a fitting leak persists, disconnect completely and check for mineral deposits or foreign material on the sealing surfaces. Clean the surfaces thoroughly and reinstall the fitting. Take the coach to an authorized service center for repairs if the system continues to leak. Follow the winterizing instructions given on p.71 to reduce the risk of leaks caused by cracks from freezing pipes. Freezing damage can be extensive and expensive.

Water Pump

The RV water pump is a 12-volt DC appliance that is activated by a switch found on the monitor panel in the kitchen area. This switch is designed to activate the pump. This is called a demand system.

Turn the faucet on when you want water. If the pump fails to turn on when the switch is activated, check the fuse located in the converter. If the pump continues to operate whether the faucet is open or closed, check the water tank to see if it is empty and check to see if there is a leak in the system.

The water pump is self-priming and totally automatic, operating upon demand when water is required.

1. Fill or partially fill freshwater supply tank.
2. Open kitchen and bathroom faucets
3. Turn on switch for water pump and allow it to fill the water lines and hot water heater.
4. Close each faucet after it delivers a steady stream of water.
5. Water pump should stop running after all faucets are closed.
6. Pump should now run when faucet is opened and stop when faucet is closed.

When using the demand system and no water comes when a faucet is turned, use the following chart to correct the problem.

TYPICAL FRESH WATER SYSTEM

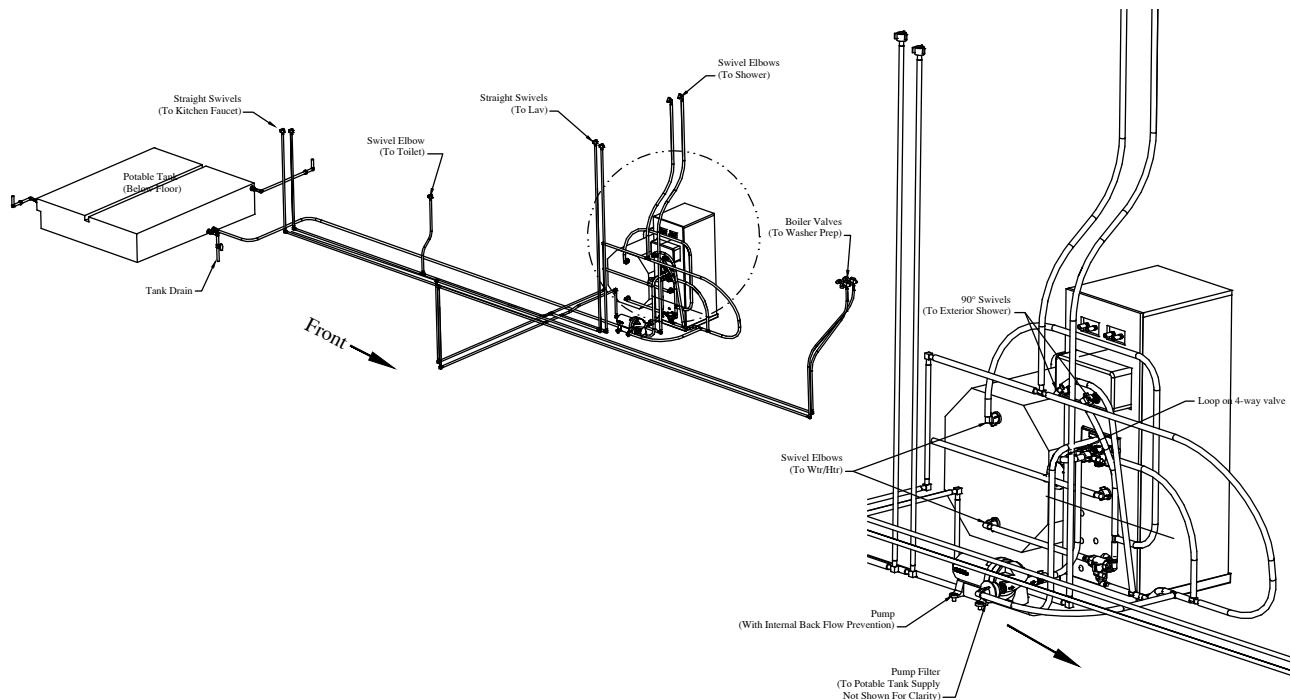

Situation	Solution
Pump Running – No Water	1.Fill Tank. 2.Clear water line to pump.
Pump Doesn't Run and no water pressure	1.Check if pump switch is on. 2.Check 12-volt fuses. 3.Check electric connection.
All water should be drained from the fresh water system when not in use for more than one (1) week.	

Note

DO NOT RUN THE WATER PUMP WITHOUT WATER IN THE SYSTEM. ALWAYS KEEP THE PUMP SWITCH OFF WHEN THE SYSTEM IS EMPTY OR WHEN CONNECTED TO CITY WATER. RUNNING THE PUMP DRY CAN DAMAGE IT AND VOID THE WARRANTY. WHEN LEAVING YOUR CAMPER OR WHEN PULLING IT DOWN THE ROAD BE SURE TO TURN OFF YOUR WATER PUMP SWITCH.

Waste Water System

The waste drainage system was designed to provide adequate and safe storage and/or disposal of waste materials. All of the materials used in the making of this system are tested by a nationally recognized testing laboratory. The drainage system uses plastic piping and fittings connected to the sinks, toilet, and holding tanks. This provides for their drainage to an outside termination. The unit should be reasonably level for best operation of the system. There are two separate waste systems. The gray water system is for waste water from the sinks and shower. The black water system is generally for sewage waste from the stool. Each tank has its own control valve, and both tanks drain through the sewer drain hose.

The drainage system also includes vents that carry odors caused by drain water and waste out of the RV, while also equalizing air pressure. Drain clean outs are provided to clean lines between fixtures and holding tanks.

Drainage P-traps

By code, all drains are equipped with P-traps to keep holding tank odors from entering the vehicle. If you detect a foul odor, which you believe is from your holding tanks, add water to all drains to ensure that your P-trap water hasn't evaporated from long term storage or splashed out of the sink and shower drain while traveling. Places to add water include the kitchen sink, bathroom sink, shower/tub, wet bar sink, and the washer/dryer drain.

Black Water Holding Tank

The tanks should be emptied frequently, or as indicated on the monitor panel and especially before travel.

Note

MOST STATES HAVE LAWS PROHIBITING EMPTYING SEWAGE ANYWHERE BUT AN APPROVED DUMPING STATION.

While camping, it is normal practice to leave our GRAY WATER HOLDING TANK valve open if your campsite is equipped with sewer hook-up. NEVER leave the BLACK WATER TANK valve open while using the coach. Since the system utilizes gravity to empty, the BLACK WATER TANK will not drain properly unless it has sufficient liquid to help drain out the solids.

Dual Gray Holding Tanks

Some models are equipped with two gray holding tanks due to the floor plan. You must use the dump lever for each tank to empty the contents. Pulling the dump lever for one tank will not empty the other. The second holding tank has its own termination valve. The gray water holding tank is primarily used for drainage from the kitchen and bath sink and shower.

Emptying Holding Tanks

To empty the holding tanks, be certain that your RV is level since the process depends upon gravity. Remove the sewage drain hose from its storage location, below the docking center. Remove the cap from the termination outlet and connect the drain hose.



To drain either holding tank, pull out the TERMINATION VALVE (see photo on next page) by pulling out the dump valve slide handle. Close the valve after the tank has drained. Flush or pour about two gallons of water through the toilet when emptying the black tank and drain again. This flushes the tank and helps clean the drain hose. Repeat as necessary.



Follow the same procedure for the GRAY WATER HOLDING TANK(S). A repeat flush is not necessary. When the tank is empty, push the dump valve handle in until it seats. Remove the hose, wash and replace it in its storage location. Replace termination outlet cap.



DRAIN THE TOILET (BLACK) HOLDING TANK FIRST.



WARNING

FAILURE TO CLOSE THE GRAY/BLACK TANKS DURING PERIODS OF STORAGE MAY ALLOW P-TRAPS TO DRY AND ALLOW METHANE GAS OR OTHER COMBUSTIBLE GASSES TO BACK UP INTO THE UNIT, CREATING A RISK OF FIRE, EXPLOSION OR POISONING.

Holding Tank Maintenance

Keep your tanks well flushed out when the vehicle is not in use. Allowing the tank to sit with any contents for more than a couple of days will ensure some sort of build-up on the monitor probes in the side of the tank and future monitor reading problems, even if this is the first time you have used your RV. One way to help flush them out is to drain them at the campground, then add approx. 10 gallons to each tank for the trip home.

Helpful Cleaning Hints

When camping there are a few things you can do to help facilitate the cleaning process later. First, you should always use some type of chemical additive in your holding tanks specifically designed for RV use. These types of chemical will break down the contents of the tank and help ensure good drainage. In addition, try using tissue designed for recreational vehicles. It will break down more than residential style tissues, and usually never clogs your drain valves.

Do's and Do Nots of Holding Tank Use

- DO** – Clean the holding tank with an approved cleaner.
- DO** – Add a special chemical additive to sanitize and improve tank action.
- DO** – Guard the tank against freeze-up.
- DO** – Keep the waste water tank dump valves closed to allow the tanks to get as full as possible to facilitate drainage.
- DO** – Keep the dump valve closed and the drain cap in place to allow use of the system when not parked at a campsite.
- DON'T** – Put facial tissues, paper, automotive type antifreeze, sanitary napkins, diapers or household toilet cleaners in your holding tank.
- DON'T** – Put foreign objects in the system that could clog or damage it in any way.
- DON'T** – Travel with full holding tanks.

Holding Tank Flush System – “No Fuss Flush”

Your unit may be equipped with a waste holding tank flushing system. When draining your sewer tank, attach a water hose to the sewer spray hookup. Open the dump valve and let the tank empty. After the tank is drained, leave the gate valve open and open the water valve to allow water to spray inside the sewage tank. This will clean the inside of the tank of any debris that may be left inside the tank. After this is done, disconnect the water hose and close the gate valve.



WARNING

DO NOT USE THE SAME HOSE FOR THE NO FUSS FLUSH THAT IS USED FOR FILLING THE FRESH WATER TANK.

APPLIANCES

Refer to the individual manufacturer's owner's manual for additional operating and safety instructions on the following equipment.

Microwave Oven

The microwave is no different than that found in your home. It relies on 110-volt power for operation and should never be used while driving down the road. Read over the microwave oven's owner's manual to find all the information on its operation and cleaning.

Propane Appliances and Equipment Maintenance

Follow the instructions and warnings noted in the appliance and equipment owner's manual as well as the ones listed below:

- Annual maintenance should be conducted on the propane appliances and equipment by an authorized dealer or repair facility.
- Insects can build nests in the burners of the various appliances and equipment. The burner and burner orifice of the propane appliances and equipment should be cleaned out by an authorized dealer or repair facility anytime circumstances or conditions warrant, but no less frequently than on an annual basis.

Gas/Electric Refrigerator

Unlike your home refrigerator, the unit on your RV can be operated on LP gas and 120-volt AC electricity. Read the owner's manual provided in your owner's packet before putting the refrigerator into operation.

The refrigerator will not operate correctly if the vehicle is not level when parked. The refrigerator coolant will not circulate properly if the unit is not level.

For best results, make sure the outside sidewall vent and roof vent are always clear of debris. Without proper circulation of the rear coils the unit will not keep food cold.

Upon initial operation, or after being stored, the refrigerator could take up to 24 hours before the unit is cool enough for use.

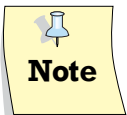

IT IS NORMAL FOR THE REAR COIL AREA OF YOUR REFRIGERATOR TO BE HOT. BE CAREFUL WHEN CHECKING THIS AREA TO MAKE SURE PROPER AIRFLOW THROUGH THE REAR VENT IS NOT OBSTRUCTED.

Furnace

Your RV is equipped with a force-air furnace similar to the type found in most homes with the exception that it is fueled by LP gas. Each unit is equipped with a wall mounted thermostat that controls the temperature. An operating manual for the furnace is included in your owner's packet.

The furnace is designed to have un-obstructed airflow from all its vents, including interior and exterior. If any vent is blocked, the furnace may shut itself off.

The furnace igniter is powered by your 12-volt battery system. If the system battery is low, the furnace blower will come on; however the furnace will not ignite. Make sure your have sufficient battery power before operating the furnace.

Your furnace is designed to sustain a desired temperature in the vehicle at most times. Due to varying weather conditions, the furnace may not be able to keep up with sub-freezing temperatures. The amount of vehicle occupants and the position the vehicle is parked may help or hinder the furnace's ability to keep up with freeze conditions. Consult the furnace owner's manual for more information

WARNING

DO NOT SUPPLEMENT THE FURNACE WITH ANY PORTABLE FUEL-BURNING APPLIANCE FOR HEATING THE INTERIOR OR THE VEHICLE. THESE APPLIANCES ARE NOT SAFE. ASPHYXIATION/CARBON MONOXIDE POISONING IS POSSIBLE IN ANY WELL SEALED SPACE AND CAN RESULT IN SERIOUS PERSONAL INJURY OR LOSS OF LIFE.

Air Conditioner

Many vehicles are equipped with a roof air conditioning system that works with electrical power from either a shore line or a portable generator.

Air conditioners are capable of cooling air a maximum of 18 to 22 degrees below ambient temperature in a 50% humidity environment. As the humidity goes up, the cooling difference goes down. If the temperature inside your coach is 100 degrees when you turn on the air conditioner, it will only put out 80 degrees. Eventually the air inside the coach will cool, and as it cools, the air put out by the air conditioner will cool also. However, when starting out at 100 degrees, this cooling could take several hours before it reaches your desired temperature. Therefore, if you know the weather will be hot, turn your air conditioner on early.

The two most common complaints with roof air conditioners are they won't turn on at all, or when they do turn on, they won't put out cold air.

Thermostat Operation

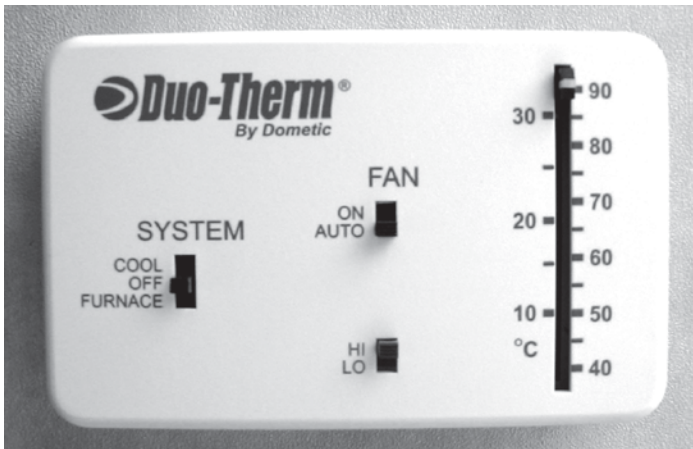

Cool Operation

1. Set System button to Cool.
2. Set slider to desired temperature.
3. Set desired fan speed (Hi or Low).
4. Set Fan operation (Auto cycles fan with compressor, or On runs fan constantly).
5. A/C runs until desired temperature is reached.

Furnace Operation

1. Set System button to Furnace.
2. Set slider to desired temperature.
3. Fan controls have no function for furnace operation.
4. Furnace runs until desired temperature is reached.

Electric Ceiling Fan Operation

The ceiling fan used in your coach is designed to ventilate the interior when cooking or if the use of your air conditioner is not desired. If used properly the roof fan can cool the interior by as much as 15 degrees within a short period of time. When used, the fan pulls hot air from high inside the coach and will pull fresh air from an open window. This fan is usually controlled by a wall-mounted thermostat (some models have a thermostat built right on the fan), which must be turned on and adjusted to your desired temperature before use. The wall-mounted thermostat is not the same

that is used for the furnace or air conditioners. Please review the supplied fan owner's manual for additional operating instructions.

To keep condensation from accumulating open the vent lids slightly to help the air circulate. Condensation occurs naturally from fluctuations in interior and exterior temperatures, humidity and dew point changes, showering and cooking.

To clean the screen, remove the screws holding it in place. Wash the screen using a non-abrasive soap and water. Re-install the screen and tighten the screws.

Keep all the vents closed when using the Rain Sensor Fan. Direct the airflow by slightly opening the window(s) on the shaded side of the trailer to obtain the maximum air flow, especially on hot, sunny days. Close all the roof vents. The area between the open window(s) and the Rain Sensor fan supplies the maximum air flow and provides the most comfort.

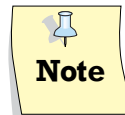

DO NOT LEAVE ANY VENT COVER OPEN WHILE THE TRAILER IS IN MOTION, STORED OR UNATTENDED FOR EXTENDED PERIODS OF TIME. HIGH WINDS OR OTHER UNUSUAL CONDITIONS OR OBSTRUCTIONS MAY DAMAGE THE COVER AND PREVENT CLOSING. LEAKAGE COULD RESULT CAUSING SERIOUS DAMAGE.

Water Heater

The water heater is accessed by a panel on the outside of the vehicle. Turn on the hot water faucet at the galley sink to see if the tank is full. Before operating any gas appliance, make sure the valve on the gas tank is open.

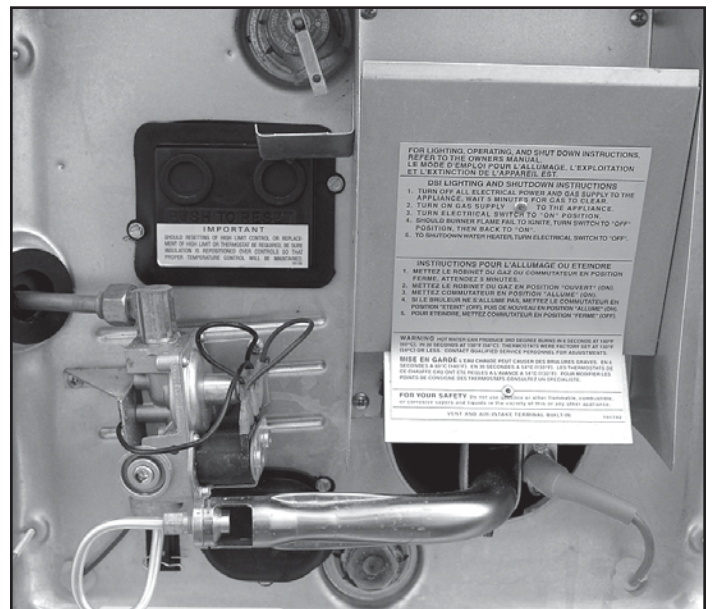

WARNING

ALL PILOT LIGHTS, APPLIANCES AND THEIR IGNITERS (SEE OPERATING INSTRUCTIONS) MUST BE TURNED OFF DURING REFUELING OF MOTOR FUEL TANKS AND/OR LP GAS CONTAINERS.

Central Vacuum (Optional)

The vacuum is built into the recreational vehicle and is in a central location. The hose receptacle is mounted in the side wall with the canister, motor and filter bag mechanism attached. Hose with various attachments are supplied.

To operate, the vehicle must be plugged into shore power. Lift the lid on the wall receptacle (vacuum will turn ON automatically) insert the hose in the receptacle and release lid. Connect desired attachment on hose and start vacuuming.

The vacuum has a thermal protector built into the motor to prevent overheating. If the motor will not operate, it will automatically reset in about ½ hour. If motor brushes canister or bearings are worn out, the circuit protector will trip Off again after a short period of time. If this happens, service should be performed by a qualified service representative.

To keep your vacuum at top efficiency, change the filter bag at regular intervals. Since cleaning schedules differ, check frequently at the beginning to determine proper interval. To maintain clean-ability, replace the filter bag when it is about ¾ full. To Change the Filter Bag: Locate canister, lift lid, and pull bag collar off connector; Open new bag, slip collar securely onto inlet connector. To reorder, check bag for instructions. To Remove Secondary Side and Bottom Filter for Cleaning: Remove bag, pull side filter out of canister; Pull bottom filter out; Clean filters and reassemble in reverse order (bottom filter must be installed first).

WARNING

TO REDUCE THE RISK OF FIRE, ELECTRIC SHOCK OR INJURY: UNPLUG AND DISCONNECT POWER BEFORE SERVICING. ELECTRIC SHOCK COULD OCCUR IF USED ON WET SURFACES. DO NOT ALLOW TO BE USED AS A TOY. USE ONLY MANUFACTURER'S RECOMMENDED ATTACHMENTS. DO NOT USE WITHOUT DUST-BAG AND/OR FILTERS IN PLACE.

EQUIPMENT

This section covers the basic operation and care of various equipment found in your Heartland RV. More detailed information as well as CAUTION or WARNING instructions about specific equipment may be found in each product manufacturer's manual. Optional equipment will also be discussed in this section which does not apply to all vehicles.

Entry Step

Entry steps folds under the vehicle when traveling. To extend step, pull assembly out from underneath the vehicle. Bottom step is folded over second step – roll bottom step out and down after step assembly is extended. To store steps, fold bottom step up over second step and push assembly underneath the vehicle.



Lubricating the Mechanism: Lubricate the mechanism every 30-60 days. Carefully clean the area around the pivot points (the rivets involved in the motion of the mechanism). After cleaning, lubricate the pivot point between the pelt (to pinpoint this area locate the washer between the parts). An automotive grade, non-staining lubricant is recommended.

Covering Nicks & Scratches: Seal a nick or scratch with automotive grade primer to prevent rust. Once the nick or scratch has been sealed, cover the damaged area with an automotive grade or high-gloss paint.

CAUTION

TO PREVENT THE POSSIBILITY OF SLIPPING ON THE ENTRY STEP AVOID EXCESS LUBRICANT ON THE SURFACE OF THE ENTRY STEP ITSELF. CAREFULLY CLEAN THE ENTIRE ENTRY STEP AFTER LUBRICATING THE MECHANISM.

Note

SILICONE LUBRICANTS AND WD-40 ARE NOT RECOMMENDED AS THEY TEND TO EVAPORATE AND DRY THE MATTED SURFACES WHICH LEAVES THEM VULNERABLE TO THE ELEMENTS.

NOTICE

IF THE VEHICLE IS TRANSPORTED WITH THE STEP IN THE EXTENDED POSITION THERE IS POSSIBILITY OF CAUSING MAJOR DAMAGE TO BOTH THE STEP AND THE VEHICLE.

Entry Door

The door uses two separate locks for personal safety and security. The door handle incorporates a primary and secondary latching system. One locking system is the door handle and the other is a dead bolt. However, keeping the entry door in good operating condition requires some routine maintenance. The following adjustments can help maintain the entry door performance.

The position of the striker plate may change over the course of time and settlement of the recreational vehicle. The setting may need to be adjusted to insure that the door operates smoothly and efficiently. To adjust the strike plate, loosen the two screws holding the plate to the jamb system. Move the plate in or out as needed to obtain a proper seal closing force. Retighten the screws.

NOTICE

IF SCREWS ARE LOOSE ON THE OUT-SWING DOORS, THE BACKER PLATE WILL RELEASE AND DROP DOWN INTO THE DOOR JAMB. SHOULD THIS HAPPEN, REPLACE THE SHORT SCREWS WITH A SCREW THAT IS LONG ENOUGH TO GO THROUGH THE JAMB SYSTEM AND INTO THE FRAME WORK OF THE SIDEWALL.

The locking cylinder requires slight lubrication on an annual basis, or as needed. Use powdered graphite, not a petroleum product which will gum the cylinder and inhibit smooth operations. The upper lock is the dead bolt, the lower lock is the privacy lock. Applying a light coating of white lithium grease to the face of the lock bolt helps in retaining a smooth close. The hinges for the door require slight lubrication annually, or as needed, with a high-quality, dry spray lubricant.

The screen door can be adjusted to sit flush in the door jamb. This requires two separate adjustments to be performed. The first adjustment made is at the screen door latch/catch itself. Loosen the two screws holding the latch to the door to permit vertical adjustment. Move the latch far enough to catch on the striker mounted at the door frame. Tighten both screws. The striker mount on the door frame permits horizontal adjustment. Again, loosen the two screws holding the striker assembly. Move the striker to center the latch and tighten the screws in place.

It is a simple procedure to replace the sliding cover. Place the slider in the center. Pull from the center of the slider; it will bow enough to allow easy removal. To re-install, reverse this procedure. Install the upper left corner first and pay attention to the location of the stop tabs.

Sofa Bed Conversion (Optional)

The sofa will convert easily into a bed. Before converting the sofa to a bed clear the area of obstruction.

Sofa to Sleeper: raise the sofa seat base until the seat base and backrest form a V shape by lifting up from the center of the sofa just below the seat cushions, push down on the seat base until the seat base and back rest are flat.

Sleeper to Sofa: Lift the seat base up until seat and back rest are in a V shape and push down on the seat base.

Roll Over Dinette & Bed (Optional)

The dinette can be used as a bed or a dinette. When not in use the dinette is stored and secured to the sidewall. There are two dinette sections used, one for each side. A fold up portable table is used and should be properly stored when in transit.

To Use The Bed: Remove straps from each section and fold all legs out, lower bed sections and fold cushions out to form the bed.

To Use The Dinette: Remove retaining straps from each section and fold out bottom cushion legs of each section only, lower each section bottom cushion to rest on the legs and rotate inner cushions to form back rests.

Dinette Bed Conversion (Optional)

To convert the dinette into a bed: remove the tabletop from the leg supports and set aside, remove the leg supports from the base and store, slide the tabletop between the booth benches allowing it to rest on the guide rail and lay both seat cushions and back cushions together to form a mattress.

Storage – Under Bed (Optional)

To use the storage compartment located under the bed, lift up the bed by the front edge of the mattress platform. Gas struts hold the mattress and platform open.

 <p>Note</p>	FOR MORE DETAILED INFORMATION AND OPERATING INSTRUCTIONS, REFER THE TO THE MANUFACTURER'S MANUAL.
--	--

Overhead Storage

The overhead storage is to be used for light weight items only.

Entertainment Center: AM/FM/CD/DVD Player

The entertainment center stereo system consists of AM/FM Stereo Tuner, CD/DVD Player and interior speakers.

 <p>Note</p>	FOR MORE DETAILED INFORMATION AND OPERATING INSTRUCTIONS, REFER THE TO THE MANUFACTURER'S MANUAL.
--	--

Television Antenna

The television antenna is a manual crank up antenna with built in electronics that use 12 Volts DC to boost signal strength. Weak signals can be amplified by turning on the boost switch. The antenna and booster work together to provide the best possible picture for most situations. Certain conditions occur when no amplification is needed and the booster may make the picture worse.

 <p>Note</p>	DO NOT MOVE THE RECREATIONAL VEHICLE WITH THE ANTENNA RAISED. DAMAGE CAN OCCUR FROM LOW TREE LIMBS OR WIRES.
--	---

 WARNING	
BEFORE RAISING THE ANTENNA MAKE AN OUTSIDE VISUAL INSPECTION FOR ANY OBSTRUCTIONS OR OVERHEAD ELECTRICAL WIRES. DAMAGE TO THE ANTENNA, SEVERE SHOCK, PERSONAL INJURY OR LOSS OF LIFE CAN OCCUR FROM INADEQUATE CLEARANCE.	

To raise the antenna, rotate the crank handle clockwise to raise the antenna (about 14-15 turns). Pull down on the outside directional wheel and rotate the antenna until the best picture is obtained (the directional wheel is spring loaded).

To lower the antenna, pull down on the directional wheel and align arrows then rotate crank handle counterclockwise lowering antenna fully into the cradle. Make an outside visual inspection to ensure the antenna is properly stowed.

SLIDE OUTS

If your trailer is equipped with a slide out precautions must be taken before operation of the slide room.

1. Make sure you have clearance on the exterior
2. Make sure that all your interior items are clear.
3. Make sure you have sufficient battery power.
4. Press and hold the slide-out room switch in the OUT position. The slide-out room will move slowly to the out position. The drive motor will not stop automatically. To stop the slide-out room before reaching the OUT position, release the switch. To continue room movement, push and hold the switch. Release the switch to lock the room into position.

NOTICE

CONFIRM THERE IS FIVE OR MORE FEET OF CLEAR SPACE OUTSIDE OF SLIDE-OUT ROOM TO THE OUT POSITION. CHECK THAT ALL CABINETS ARE CLOSED BEFORE EXTENDING OR RETRACTING THE ROOMS.

NOTICE

DO NOT OPERATE THE SLIDE-OUT ROOM WHEN THE BATTERY HAS BEEN REMOVED FROM THE FIFTH WHEEL. OPERATING THE SLIDE-OUT BY USING ONLY THE CONVERTER MAY DAMAGE THE SLIDE-OUT ELECTRICAL COMPONENTS. CONTINUOUS OPERATION OF THE SLIDE-OUT ROOM CAN DRAIN THE BATTERY AND DAMAGE THE SLIDE-OUT MOTOR FROM OVERHEATING. NEVER MOVE THE TRAILER WITHOUT HAVING THE SLIDE-OUT ROOM RETRACTED.

NOTICE

DIRT AND GRIT TRAPPED UNDER THE SLIDE COULD RESULT IN DAMAGE TO THE FLOOR. LEAVES, TREE LIMBS AND OTHER DEBRIS COULD DAMAGE THE SLIDE-OUT ROOF AND SEALS. CLEAN SLIDE-OUT ROOF BEFORE OPERATING.

NOTICE

SEVERE WEATHER CONDITIONS SUCH AS HIGH WINDS OR HEAVY RAIN MAY CAUSE DAMAGE TO AN EXTENDED SLIDE-OUT.

NOTICE

DO NOT EXTEND THE SLIDE ROOM IN SNOW, SLEET, ICE OR FREEZING RAIN. THERE MAY BE EXTENSIVE DAMAGE RESULTING FROM THE AWNING FREEZING. IN THE EVENT THE SLIDE-OUT ROOM IS EXTENDED IN SNOW, SLEET, ICE OR FREEZING RAIN CONDITIONS, CLEAR THE AWNING AND ENSURE FREE MOVEMENT PRIOR TO RETRACTING THE SLIDE ROOM.

Retracting Slide Outs

1. Make sure you have clearance on the interior.
2. If applicable – clean the floor.
3. Remove any debris from the top of the slide-out room.
4. Press and hold switch in the IN position. To stop slide-out room before it fully retracts, release the switch. To continue the room movement, push and hold the switch in. When the room is fully retracted, release the switch to lock into position.



Slide Out Awning (Optional)

The slide out awning is automatic. When the slide-out moves in or out, the cover reacts to the slide-out direction. A fixed edge of the slide out cover is installed into an awning rail, mounted just above the slide out. A spring-loaded roller with special brackets mounts to the slide out. In a hard rain, the cover helps prevent water from penetrating the seal of the slide-out.

The slide out cover will extend automatically attaining full coverage when the slide out achieves maximum extension. The slide-out cover retracts automatically and rolls up to the travel position when the slide-out is completely closed.

**Note**

WATER MAY POOL ON TOP OF THE EXTENDED COVER. AS THE SLIDE-OUT IS RETRACTED, THE WATER IS REMOVED.

**Note**

WHEN RETRACTING THE SLIDE-OUT, STOP THE ROOM ABOUT HALFWAY CONFIRM THAT THE FABRIC IS ROLLING PROPERLY BEFORE FULLY RETRACTING THE SLIDE OUT.

Electric Slide Out Systems

Electrically operated slide out rooms utilize a gear drive to move in and out. Each guide ram on the underside of the room has its own gear, which is driven by a shared electric motor. Several different types of electric systems are used on HEARTLAND RECREATIONAL VEHICLES, LLC products, depending on the model. But each is able to be operated by a hand crank in the event of a motor or power failure.

Slide Out Circuit Breakers

If attempting to move the slide and it is perceived that the electric motor has no power, inspect the breakers and fuses. If a fuse is blown you may need to replace it.

Slide Out Weather Seals

Frequently check all seals and gaskets on the slide out walls for proper fit and operation. The seals and gaskets should be coated with a silicone spray for easier operation and weather protection.

Inspect the condition of the slide tubes (not the hydraulic ram) under the slide out, and if needed, use bearing grease for ease of operation.

Although every attempt is made to have 100% air-tight seal, you will find that the best seal possible can be achieved with proactive maintenance and proper use.

Hydraulic Slide Out System

The hydraulic slide out system uses a 12-volt DC power motor to drive a hydraulic pump, which moves fluid through a system of hoses into a dual directional hydraulic actuator to extend and retract the room(s). Electricity for the pump motor and assembly is supplied by the RV Battery. A simple press and release wall mounted switch provides normal operation to extend and retract the slide out room(s).

Typical maintenance for the pump would be to verify and add an automotive type a fluid for the pump. The pump has a see thru reservoir that makes checking for proper level easy. For best performance, the fluid level should be within ½ inch of the top of the reservoir with all room(s) retracted (closed). It is recommended to check the fluid level every month.

The Hydraulic pump is wired to an auto reset breaker that is mounted within 18 inches of the RV battery. If an electrical overload would occur, this breaker would interrupt the operation of the slide out room temporarily. Causes for this to occur could be a low battery, loose or corroded battery terminals or ground wire. The slide room may be binding (unit may not be level, sticks, leaves, or other wedged items between the room and the wall). The slide room and system may be out of adjustment. Something may be blocking the extension or retraction of the slide room.

The hydraulic system can be manually overridden in case of failure or when electrical power is either interrupted or not available. For proper operation, please refer to the manufacturer's instructions supplied with your unit.

Please refer to the manufacturer's instructions supplied with your unit for proper care and operation of the hydraulic system.

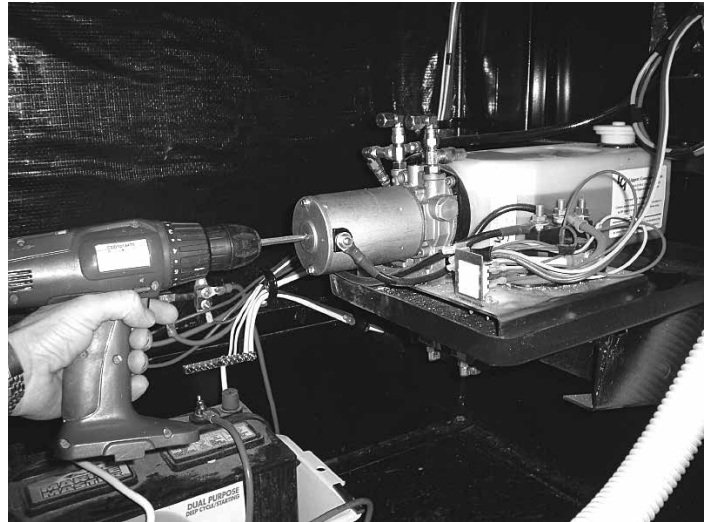

EXTERIOR MAINTENANCE

Please refer to the Maintenance Schedule at the beginning of this manual.

Seals

The seals around doors, windows, vents and external seams must be checked every 3 months or change of season. If deterioration is noted, reseal the seams or seals with an approved sealant to prevent leaks. Your dealer can perform the resealing inspections and work for you. Your dealer is also able to inform you of the appropriate sealants to be used, if you prefer to do the job yourself. Sealants can be purchased from your dealer or manufacturer. Seals are not covered under warranty.

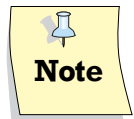

HEARTLAND RECREATIONAL VEHICLES, LLC, DOES NOT RECOMMEND THIS RV FOR USE IN THE WINTER UNLESS IT IS EQUIPPED WITH ADDITIONAL INSULATION AND PROPERLY SEALED UNDERBELLY. SEE YOUR DEALER OR CONTACT HEARTLAND FOR MORE DETAILS.

Rubber Roof

The rubber roof system should be cleaned periodically and inspected for tears or voids in the sealants (see maintenance schedule). When cleaning the rubber roof you only need to use a mild detergent, plenty of water, and a medium bristle scrub brush. Special cleaners are not necessary. You should check with the rubber roof manufacturer prior to using cleaners, coatings or sealants advertised to prolong the life of your rubber roof, as they are not necessary.

When cleaning your roof it is recommended that you use a long handled bristle brush and a steady ladder to reach all parts of the roof.

Lack of maintenance may allow mildew to form and discolor the rubber membrane. Although this may be unsightly, it is not cause for roof replacement. Simply use a scrub brush to clean as much as possible and touch up and areas of sealant that look suspicious. This is not covered under warranty.

Rubber Roof Repair

Small tears or punctures in the rubber roof membrane can easily be repaired and will have the same life span as the rest of the rubber roof. Most RV dealers carry rubber roof repair kits at a very nominal price. Please refer to your specific repair kit for proper applications.

Fiberglass Exterior Skin

Wash the RV with a quality, mild soap. There are special fiberglass cleaners on the market and available at most RV dealers. **DO NOT USE STRONG ALKALINE CLEANERS OR CLEANERS WITH ABRASIVES.**

Waxing the exterior will further protect the outside surfaces. **USE A WAX FORMULATED FOR FIBERGLASS.** Follow the instructions found on the product label.

When washing and waxing the exterior of your RV, be sure to inspect all seams and trim for damaged or missing sealants. Occasionally during washing some sealants may be washed away, and harsh climates can accelerate the deterioration of sealants. As a guideline, inspect these areas four (4) times a year or whenever the RV is washed or waxed, whichever is more frequent. Unsealed areas can lead to expensive structure repairs in the future.

The bonded fiberglass wall may show a “print through” of the inner structure supports and beams. This is normal and may be more evident in harsh climates.

Washing

The exterior of your new recreation vehicle is made of pre-finished aluminum or fiberglass. Frequent washing and thorough cleaning is recommended to prevent damage to the vehicle finish caused by exposure to calcium chloride, road tar, tree sap, insects and other foreign material. Corrosive materials, such as those used for ice and snow removal and dust control, also accumulate on the underside of the vehicle. These materials should be removed by flushing the underbelly regularly with water, especially areas where mud and other foreign materials collect. The change of corrosion can be minimized by frequent washings of the vehicle.

Corrosion Protection

Your HEARTLAND RECREATIONAL VEHICLES, LLC recreational vehicle has been designed to withstand normal environmental condition. But, the sand and salt used on the highways and the salt spray in the air near oceans can cause the metal components on your recreational vehicle to corrode.

To protect your recreational vehicle from this corrosion, it must be thoroughly cleaned as soon as possible after exposure to these elements. Washing the undercarriage with a high-pressure washer will remove the majority of

the salt. But, this will not replace the paint that is literally sandblasted off the undercarriage by the road salt and sand. Sandblasted and corroded frame components must be refinished. This is not covered under warranty. This can be done with readily available rust preventative paint and undercoating. This is necessary to properly maintain your recreational vehicle.

Aftermarket undercoating processes are also beneficial in rust prevention. But, to remain effective, these treatments must be inspected and renewed annually as most undercoating agents can dry and peel with age.

Therefore, regularly scheduled inspections and maintenance are necessary to protect your recreational vehicle and its various components and fixtures from the elements and keep it corrosion-free.

In addition to maintenance, you should keep from storing your vehicle in grassy areas for long periods of time. The stagnant, moist air developed under the coach will speed up the corrosion process. Always store your vehicle on pebble, concrete or asphalt surfaces.

Awnings

Awnings installed on your trailer may have been added by your dealer. Proper use, care and maintenance procedures for awnings are included in the literature provided with the awning.

To open your main awning (Electric):

Press and hold the “Extend” button and the awning will automatically open. If the button is released the awning will stop. Continue pressing the button until awning is fully extended, then release.

To close your main awning (Electric):

Press and hold the “Retract” button and the awning will automatically close. If the button is released the awning will stop. Continue pressing the button until awning is fully retracted, then release.

NOTICE

**VISUALLY VERIFY THAT THE AWNING IS FULLY CLOSED
AN AWNING LEFT PARTIALLY OPEN CAN DISLodge DURING HIGH
WIND OR TRAVEL**

⚠ WARNING

**BE SURE TO LOCK YOUR AWNING WHEN YOU CLOSE IT UP. FAILURE TO
DO SO CAN RESULT IN SERIOUS PERSONAL INJURY OR LOSS OF LIFE.**

Awning Care

Be sure to clean off all debris as you roll up your awnings. Periodically wash of the awning fabric with a soapy water solution. Long term exposure to the sun may cause some fading over time, which is normal.

INTERIOR CARE

The fading of upholstery, carpet and other interior fabrics is generally caused by excessive sunlight. The drapes, blinds or shades should be kept closed when the vehicle is parked for an extended period of time to minimize fading. Normal deterioration of appearance items due to wear and/or exposure is not covered by the HEARTLAND RECREATIONAL VEHICLES, LLC Limited Warranty.

Upholstery

Do not launder upholstery fabrics. Blot up stains promptly, before they set. Use an upholstery cleaner or mild solvent, depending on the stain. Never soak the fabric. Use as little water as possible. Blot rather than rub. Towel dry or have professionally cleaned.

Fabrics and Draperies

The fabrics that may be used in this vehicle for the bedspread, draperies, headboard and valances may be damaged by the use of improper cleaning products. Therefore, cleaning instructions for these items are DRY CLEAN ONLY. Water-based products are not recommended for cleaning the fabrics in your new unit. Most water-based household cleaning products are not formulated for use on these fabrics and may cause excessive shrinkage or fading.

Spills, spots or stains should be treated as soon as possible to avoid permanent damage. If a spill occurs, blot the fluid with a dry towel. Do not rub; rubbing may cause the liquid to “set” in the fabric. When attempting to clean a spot or stain, always start from the outside and work inward to avoid spreading it further. Some stains or soils are extremely difficult or impossible to be removed completely. These should receive immediate, professional attention. Spills, spots, stains or soils are the responsibility of the owner and are not covered by the HEARTLAND RECREATIONAL VEHICLES, LLC Limited Warranty.

WARNING

WHEN CLEANING THE UPHOLSTERY AND FABRIC IN THE UNIT, DO NOT USE LACQUER THINNER, NAIL POLISH REMOVER, LAUNDRY SOAPS, OR BLEACH. NEVER USE CARBON TETRACHLORIDE OR GASOLINE FOR ANY CLEANING PURPOSES. THESE ITEMS MAY CAUSE DAMAGE TO THE MATERIALS BEING CLEANED AND MOST ARE HIGHLY FLAMMABLE. FAILURE TO HEED THIS WARNING CAN RESULT IN SERIOUS PERSONAL INJURY OR LOSS OF LIFE.

Carpet

Weekly vacuuming the carpet and fabrics throughout the vehicle is recommended to prevent an accumulation of dirt that can detract from the material’s appearance and shorten its life.

Countertops

Countertops are made of several materials that are highly resistant to normal spills and scuffs. Avoid regular use of abrasive pads and scouring powders which will dull the surface and make it more stain-prone. Confine knife blades and slicing to a chopping block (not supplied). Pots and pans straight from the oven or burner and irons should be placed on lined hot pads.

Appliances

Refer to the individual manufacturer’s owner’s manuals for proper care and cleaning of your appliances.

Walls

The walls should be cleaned periodically to maintain a new appearance. Use a non-abrasive cleaner with a soft cloth.

Ceilings

Use a damp cloth to clean the ceiling. Clean with a mild detergent in warm water. Never use a strong chemical. Excessive moisture may damage the ceiling.

Interior Finish

The interior surfaces are easy to clean with mild soap and damp cloth. Waxing is unnecessary. Stubborn stains may be removed with a spray cleaner. Scratches can usually be touched up with a good quality commercial furniture scratch remover.

Tub and Lavatory

Do not use steel wool, harsh abrasives or liquid cleaners with solvents. These surfaces are best cleaned with soap and water or dishwashing detergent and water.

Windows

The windows in your vehicle should open and close easily. If they become clogged with dirt, clean the mechanism with a small, stiff brush and spray with a silicone lubricant.

Doors and Drawer Fronts

The doors and the drawer fronts in your unit are made of high quality wood. They should be wiped off with a dust cloth and a good household cleaner.

Bedspreads

The manufacturer of the bedspreads recommends that the bedspreads not be washed, but professionally dry cleaned.

WINTER STORAGE

Winter Storage Recommendations

1. Level the unit – front to rear and side to side.
2. Remove bottled and canned goods and other items that could be damaged by freezing.
3. Open all the faucets, valves and drains (including the toilet stool valve), water heater drain and line drain.
4. Run demand pump till water stops flowing from faucets. Shut pump off immediately. Allow drains, faucets and valves to remain open for several hours or blow all extra water out with air. Be sure lines are empty.
5. Close all faucets, valves and drains.
6. It is a good idea to use an antifreeze solution for potable water for more positive protection. Do not use automotive type antifreeze.
7. Before using vehicle again, you may want to sanitize the system.
8. Completely drain holding tanks.
9. Flush sink, shower-tub, lavatory and stool with a solution of hot water and dish soap. Allow to fully drain and flush with clean hot water.
10. If possible, agitate the water in the holding tanks by driving a few miles, then drain tanks again.
11. An alternate to step #9 is to use a chemical deodorant. Let mixture stand for a few days, then drain.
12. Flush with fresh water, drain, and after tanks are dry, close dump valves and drain cap.
13. Fill traps with an antifreeze approved for use in ABS plastic pipes. Normally, a cupful per trap is adequate. Do not use an antifreeze solution with an alcohol base.
14. Turn the thermostat off.
15. Put graphite in all the locks and lubricate all door hinges.
16. Close all windows and roof vents.

Winterizing the Water Pump

With the water drained from the potable water tank, disconnect the water pump outlet hose and then turn the pump on to allow the remaining water to be pumped out (less than one cup).

NOTICE

DRAINING THE WATER SYSTEM ALONE MAY NOT BE ENOUGH TO PROVIDE COMPLETE COLD WEATHER PROTECTION FOR AN RV UNIT THAT WILL BE STORED IN AN UNHEATED ENVIRONMENT WHERE TEMPERATURES DROP BELOW FREEZING. CONSULT YOUR DEALER FOR MORE INFORMATION ON THE BEST METHOD OF WINTERIZING YOUR VEHICLE.

If you desire, you can blow out the water lines with compressed air by opening all valves and placing the air nozzle into the system where the outlet hose has disconnected. Replace pump hose.

Water System Winterizing

1. Drain the fresh water tank.
2. Drain pipes by turning the water pump ON and opening a cold water faucet. Wait for the water flow to stop. Turn pump OFF. Leave faucets OPEN.
3. Turn ON all faucets.
4. OPEN the WATER HEATER drain valve located at the bottom of the heater (or remove plug). Let the water drain out. OPEN the heater SAFETY VALVE.
5. Bypass the water heater.
6. Use the siphon hose to add RV anti-freeze to your system, or use air-pressure to remove all remaining water from the system.
7. After each faucet has been opened, drained, and closed, CLOSE the WATER LINE DRAIN VALVES.
8. Drain the WASTE WATER HOLDING TANK.
9. Double check that ALL WATER has been drained.
10. Some water may remain in the fresh tank. This will not damage the tank.

WARNING

DO NOT USE AUTOMOTIVE ANTI-FREEZE OR WINDSHIELD WASHER FLUID ANTI-FREEZE IN THE VEHICLE'S WATER SYSTEM. THESE CAN BE HARMFUL OR FATAL IF SWALLOWED. YOUR DEALER CAN PROVIDE YOU WITH SPECIAL ANTI-FREEZE THAT IS SAFE AND APPROVED FOR RV WATER SYSTEMS. ALWAYS FOLLOW MANUFACTURER'S INSTRUCTIONS FOR THESE ADDITIVES

Water Heater Bypass

To bypass the water heater, turn the top and bottom valves off and the middle valves on.

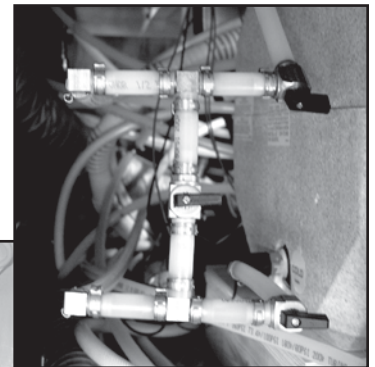

Water Heater Bypass
(One Valve System)



PROLONGED OCCUPANCY

Effects

Your trailer was designed primarily for recreational use and short-term occupancy. If you expect to occupy the trailer for an extended period, be prepared to deal with condensation and the humid conditions that may be encountered. The relatively small volume and tight compact construction of modern recreation vehicles means that the normal living activities of even a few occupants will lead to rapid moisture saturation of the air contained in the trailer and the appearance of visible moisture, especially in cold weather. This is also not covered under warranty.

Just as moisture collects on the outside of a glass of cold water during humid weather, moisture can condense on the inside surfaces of the trailer during cold weather when relative humidity of the interior air is high. This condition is increased because the insulated walls of a recreation vehicle are much thinner than house walls.

Estimates indicate that a family of four can vaporize up to three gallons of water daily through breathing, cooking, bathing, and washing. Unless the water vapor is carried outside by ventilation, or condensed by a dehumidifier, it will condense on the inside of the windows and walls as moisture, or in cold weather as frost or ice. It may also condense out of sight within the walls or the ceiling where it will manifest itself as warped or stained panels. Appearance of these conditions may indicate a serious condensation problem. When using your trailer, you should at all times take necessary action to minimize the effects of excessive moisture and condensation. For tips on controlling condensation see the "Tips To Controlling Condensation" section.

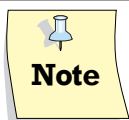

Note

YOUR TRAILER IS NOT DESIGNED, NOR INTENDED, FOR PERMANENT HOUSING. USE OF THIS PRODUCT FOR LONG TERM OR PERMANENT OCCUPANCY MAY LEAD TO PREMATURE DETERIORATION OF STRUCTURE, INTERIOR FINISHES, FABRICS, CARPETING, AND DRAPES. DAMAGE OR DETERIORATION DUE TO LONG-TERM OCCUPANCY IS NOT CONSIDERED NORMAL, AND MAY UNDER THE TERMS OF THE WARRANTY CONSTITUTE MISUSE, ABUSE, OR NEGLIGENCE, AND THEREFORE VOID CERTAIN WARRANTY PROTECTIONS.

Ventilation and Moisture Control

You can reduce interior moisture condensation by taking the following steps:

1. **Ventilate with outside air.** Partially open one or more roof vents and one or more windows to provide circulation of outside air into the interior. While this ventilation may increase furnace heating load during cold weather, it will greatly reduce water condensation. Even when it is raining or snowing, ventilation from outside will be far drier than interior air and will effectively reduce condensation inside the trailer.
2. **Minimize moisture released inside the trailer.** Run the range vent fan when cooking and the vent fan (or open the bath vent) when bathing to carry water vapor out of the trailer. Avoid making steam from excessive boiling or use of hot water. Remove water or snow from shoes before entering to avoid soaking the carpet. Avoid drying overcoats or other clothes inside the trailer.

WARNING

FIRE HAZARD

DO NOT USE COOKING APPLIANCES FOR COMFORT HEATING. COOKING APPLIANCES NEED FRESH AIR FOR SAFE OPERATION.

BEFORE OPERATION:

1. **OPEN OVERHEAD VENT OR TURN ON EXHAUSE FAN, AND**
2. **OPEN WINDOW.**

In addition to the hazards of toxic fumes and oxygen depletion, open flames add moisture to the interior air, increasing condensation. Do not use an air humidifier inside the trailer. Water put into the air by the humidifier will greatly increase condensation.

3. **Ventilate closets and cabinets.** During prolonged use in very cold weather, leave cabinet and closet doors partially open to warm and ventilate the interiors of storage compartments built against exterior walls. The air flow will warm the exterior wall surface, reducing or eliminating condensation and minimizing possible ice formation.

4. **Install a dehumidifier.** During prolonged, continuous use, a dehumidifying appliance may be more comfortable and effective in removing excess moisture from the interior air. While use of a dehumidifier is not a “cure-all”, and ventilation, storm windows and moisture reduction continue to be important, operation of the dehumidifier will reduce the amount of outside air needed for ventilation. Heating load on the furnace will be reduced and the interior will be less drafty.

 **WARNING**

DO NOT COVER EMERGENCY EXIT WINDOW(S). THIS WINDOW MUST BE LEFT ACCESSIBLE AT ALL TIMES FOR EMERGENCY EXIT.

Dripping Ceiling Vents

During cold weather and even in short term occupancy, condensation frequently forms on ceiling vents and may even accumulate to the point of dripping onto the surfaces below. This is frequently misinterpreted as a “leaking” roof vent but is most often condensation drippage. Follow the preceding steps to control moisture condensation; protect surfaces with plastic sheeting until the moisture has dissipated.

 **WARNING**

UREA-FORMALDEHYDE IS USED IN THE PRODUCTION OF PARTICLE BOARD, HARDWOOD PLYWOOD, AND MOST PANELING. UREA-FORMALDEHYDE RESIN MAY RELEASE FORMALDEHYDE VAPORS INTO THE AIR, WHICH MAY CAUSE HEADACHES, AND IN SOME PEOPLE, EYE, NOSE, AND THROAT IRRITATION. FORMALDEHYDE MAY INTENSIFY SOME ALLERGIES OR UPPER RESPIRATORY PROBLEMS LIKE ASTHMA. PROPER VENTILATION SHOULD REDUCE THE RISK OF SUCH PROBLEMS.

ABOUT MOLDS

What are molds?

Molds are microscopic organisms that naturally occur in virtually every environment, indoors and out. Outdoors, mold growth is important in the decomposition of plants. Indoors, mold growth is unfavorable. Left unchecked, molds break down natural materials, such as wood products and fabrics. According to the Center for Disease Control, exposure to damp and moldy environments may cause a variety of health effects, or none at all. Some people are sensitive to molds. For these people, molds can cause nasal stuffiness, throat irritation, coughing or wheezing, eye irritation, or, in some cases, skin irritation. People with mold allergies may have more severe reactions. Immune-compromised people and those with chronic lung illnesses, such as obstructive lung disease, may get serious infections in their lungs when they are exposed to mold.

What factors contribute to mold growth?

For mold growth to occur, temperatures, indoor or outdoors, must be between 40 degrees and 100 degrees Fahrenheit and also have a source of moisture, such as humidity, standing water, damp materials, etc. Indoors, the most rapid growth occurs with warm and humid conditions.

How can mold growth be inhibited?

By controlling relative humidity, the growth of mold and mildew can be inhibited. In warm climates, use of the air conditioner will reduce the relative humidity. Vents are located in the bathing and cooking areas and constant use is advised during food preparation and bathing, even during colder weather. Additionally, opening a window during these activities will assist in ventilation. In extremely humid conditions, the use of a dehumidifier can be helpful.*

Frequent use of your RV or cleaning regularly is an important preventive measure. Further, any spills should be wiped up quickly and dried as soon as possible. Avoid leaving damp items lying about. On safe surfaces, use mold or mildew killing cleaning products. Check sealants regularly, and reseal when necessary to avoid water leaks. Proper preventive maintenance to the RV and its accessories, as described both in this manual and in accompanying literature, will provide the best protection to the RV.

For more information of controlling moisture in the RV, please read, "Tips to Controlling Condensation," located in this manual.

*If using a dehumidifier, please read and follow all manufacturer instructions and recommendations to the use and cleaning of the dehumidifier.

Tips to Controlling Condensation

To avoid condensation problems, try to follow these tips to help alleviate excess moisture.

- Allow excess moisture to escape to the outside when bathing, washing dishes, hair drying, laundering, and using appliances and non-vented gas burners.
- Always use the vent hood when cooking.
- Keep the bathroom door closed and the vent or window open when bathing and for a period of time after you have finished.
- Do not hang wet clothes in the vehicle to dry.
- In hot weather, start the air conditioner early as it removes excess humidity from the air while lowering the temperature.
- Keep the temperature as reasonably cool during cold weather as possible. The warmer the vehicle, the more cold exterior temperatures and warm interior temperatures will collide on wall surfaces, thus creating condensation.
- Use a fan to keep air circulating inside the vehicle so condensation and mildew cannot form in dead air spaces. Allow air to circulate inside closets and cabinets (leave doors partially open). Please keep in mind that a closed cabinet full of stored goods prevents circulation and allows the exterior temperature to cause condensation.
- The natural tendency would be to close the vehicle tightly during cold weather. This will actually compound the problem. Simply put, you need to remove some of the warm air, and allow some cool outside air to get inside the vehicle, so the furnace will not recycle the humid interior air.
- Use fluorescent ceiling lights and minimize prolonged use of incandescent lights, which produce heat and contribute to condensation in the roof above the ceiling lights.

CHEMICAL SENSITIVITY

After you first purchase your new recreational vehicle and sometimes after it has been closed up for an extended period of time you may notice a strong odor and chemical sensitivity. This is not a defect in your recreational vehicle. Like your home, there are many different products used in the construction of recreational vehicles such as carpet, linoleum, plywood, insulation, upholstery, etc. Formaldehyde is also the by-product of combustion and numerous household products, such as some paints, coatings and cosmetics. However, recreational vehicles are much smaller than your home and therefore the exchange of air inside a recreational vehicle is significantly less than a home. These products, when new or when exposed to elevated temperatures and/or humidity, may “off-gas” different chemicals, including formaldehyde. This off-gassing, in combination with the minimal air exchange, may cause you to experience irritation of the eyes, nose, and throat and sometimes headache, nausea, and a variety of asthma-like symptoms. Elderly persons and young children, as well as anyone with a history of asthma, allergies, or lung problems, may be more susceptible to the effects of off-gassing.

Formaldehyde

Most of the attention regarding chemical off-gassing surrounds formaldehyde. Formaldehyde is a naturally occurring substance. It is also a key industrial chemical used in the manufacture of the numerous consumer products which we referred to above and used in the construction of recreational vehicles. Trace levels of formaldehyde are also released from smoking, cooking, use of soaps and detergents such as carpet shampoos, cosmetics, and many other household products. Some people are very sensitive to formaldehyde while others may not have any reaction to the same levels of formaldehyde. Amounts released decrease over time.

Ventilation

To reduce or lessen exposure to chemicals from off-gassing it is of utmost importance that you ventilate your recreational vehicle. Ventilation should occur frequently after purchase and at times when the temperatures and humidity are elevated. Remember off-gassing is accelerated by heat and humidity. Open windows, exhaust vents, and doors. Operate ceiling and/or other fans, roof air conditioners, and furnaces and use a fan to force stale air out and bring fresh air in. Decreasing the flow of air by sealing the recreational vehicle increases

the formaldehyde level in the indoor air. Please also follow the recommendations contained in this chapter regarding tips to avoid condensation problems. Many of the recommendations contained in this chapter will assist in avoiding exposure to chemicals that off-gas.

Do Not Smoke

Finally, we recommend that you **do not smoke inside your recreational vehicle**. In addition to causing damage to your recreational vehicle, tobacco smoke releases formaldehyde and other toxic chemicals.

Medical Advice

If you have any questions regarding the health effects of formaldehyde, please consult your doctor or local health department.

Warranty Exclusion

CHEMICAL OFF-GASSING IS NOT A “DEFECT” IN YOUR RECREATIONAL VEHICLE AND IS NOT COVERED BY THE LIMITED ONE-YEAR WARRANTY. PLEASE FOLLOW THE RECOMMENDATIONS IN THIS SECTION TO ADDRESS THIS CONCERN.

This vehicle contains composite wood products that comply with the applicable California Code of Regulations section 93120.2(a) Phase 2 (P2) formaldehyde emission standards specified on the above date of manufacture.

